

TP9300 DMR Portable Radios

Specifications Manual

MPD-00005-11 · Issue 11 · June 2023

Contact Information

Tait Communications Corporate Head Office

Tait International Limited
P.O. Box 1645
Christchurch
New Zealand

Imported into the EU by:	Imported into the UK by:
Tait Communications GmbH	Tait Europe Limited
Stipcakgasse 40	Unit A, Buckingham Business Park,
1230 Vienna	Anderson Road
Austria	Swavesey
	Cambridge, CB24 4UQ
	United Kingdom

For the address and telephone number of regional offices, refer to our website:
www.taitcommunications.com

Copyright and Trademarks

All information contained in this document is the property of Tait International Limited. All rights reserved. This document may not, in whole or in part, be copied, photocopied, reproduced, translated, stored, or reduced to any electronic medium or machine-readable form, without prior written permission from Tait International Limited.

The word TAIT and the TAIT logo are trademarks of Tait International Limited.

All trade names referenced are the service mark, trademark or registered trademark of the respective manufacturers.

By using a Tait product you are agreeing to be bound by the terms of the Tait Software Licence Agreement. Please read the Tait Software Licence Agreement carefully before using this Tait product. If you do not agree to the terms of the Tait Software Licence Agreement, do not use the Tait Product. The full agreement is available at https://www.taitcommunications.com/our-resources/legal#Tait_Software_Licence_Agreement

Disclaimer

There are no warranties extended or granted by this document. Tait International Limited accepts no responsibility for damage arising from use of the information contained in the document or of the equipment and software it describes. It is the responsibility of the user to ensure that use of such information, equipment and software complies with the laws, rules and regulations of the applicable jurisdictions.

Enquiries and Comments

If you have any enquiries regarding this document, or any comments, suggestions and notifications of errors, please contact your regional Tait office.

Updates of Manual and Equipment

In the interests of improving the performance, reliability or servicing of the equipment, Tait International Limited reserves the right to update the equipment or this document or both without prior notice.

Intellectual Property Rights

This product may be protected by one or more patents or designs of Tait International Limited together with their international equivalents, pending patent or design applications, and registered trade marks, for a complete list please check https://www.taitradio.com/our-resources/legal#Intellectual_Property

This product may also be made under license under one or more of the following patents:

- US7203207, AU2004246135, CA2527142, GB2418107, HK1082608, MY134526, US8306071
- US7339917, AU2004246136, CA2526926, GB2418812, MY134217
- US7499441, AU2005262626, CA2570441, GB2430333, JP4690397, NZ551231, KR100869043, RU2351080, BRP10512052, MXPA06015241
- US 7200129, AU2005226531, CA2558551, CN1930809, GB2429378, JP4351720, BRP10508671, NZ549124, KR848483, RU2321952

Environmental Responsibilities

Tait International Limited is an environmentally responsible company which supports waste minimization, material recovery and restrictions in the use of hazardous materials.

The European Union's Waste Electrical and Electronic Equipment (WEEE) Directive and UK WEEE Regulation 2013 requires that this product be disposed of separately from the general waste stream when its service life is over. For more information about how to dispose of your unwanted Tait product, visit the Tait WEEE website at www.taitcommunications.com/our-resources/compliance#WEEE. Please be environmentally responsible and dispose through the original supplier, or contact Tait International Limited. Tait will comply with environmental requirements in other markets as they are introduced.

Contents

1	Preface	5
	Scope of Manual.	5
	Associated Documentation.	6
	Product Codes.	6
	Publication Record.	7
	Regulatory Requirements and Industry Standards.	8
	Certification	8
	Performance Figures.	11
	Definition of NB and WB	11
	Frequency Bands	11
	Australia and New Zealand Citizens Band.	12
	FCC Narrowbanding Regulations	13
2	Receiver Specifications	14
	Analog	15
	Digital.	17
3	Transmitter Specifications	18
	Analog	19
	Digital.	21
4	General Specifications	22
	Radio Specifications.	23
	User Interface	23
	Radio Size, Weight, and Finish.	24
	Accessory Connector	25
	Environmental.	26
	Frequencies and Channels.	27
	Number of Networks, Zones, Channels and Groups	28
	Location Services	28
	Operational Features	29
	Current Consumption	30
	Battery Specifications.	31
	Battery Size, Weight, and Finish	31
	Expected Shift Life	32
	Temperature Range for Charging and Operating	33
	Battery Charger Specifications.	34
	Charge Temperature	35
	Charge Times Using Chargers for Non-IS/Ni Batteries.	35
	Charge Times Using Charger for IS/Ni Batteries.	35
	Charger Specifications for Non-IS/Ni Batteries.	36

Charger Specifications for IS/Ni Batteries	36
LED Indicators	36
Charger Mechanical Dimensions	37

1 Preface

Scope of Manual

This manual lists some of the regulatory requirements and industry standards that the TP9300 series of portable radios satisfy, and explains how the radio specifications were derived. Separate chapters compare the performance of the receiver ([Section 2](#)) and of the transmitter ([Section 3](#)) with requirements specified by the European Telecommunications Standards Institute (ETSI) and the Telecommunications Industry Association (TIA). [Section 4](#) provides general radio, battery, and charger specifications.

- ① The TP9300 specifications in this manual are typical performance figures and are intended only to provide guidance. They are subject to change without notice and should not form part of any contract. To establish whether the radio meets the regulatory requirements that apply to you, please contact your regional Tait office.
- ① For known issues and limitations that may cause a radio to perform outside the specifications listed here, see the software release notes for the TP9300. Software release notes are on the Tait support website, <http://support.taitradio.com>.

Associated Documentation

Title	IPN/Item code
Safety and Compliance Information	MTA-00011-xx
Safety and Compliance Information for Intrinsically Safe Portable Radios with AEx, Ex, and Non-Incendive Certification	MPD-00027-xx
Safety and Compliance Information for Intrinsically Safe Portable Radios with ATEX and IECEx Certification	MPD-00013-xx
Li-ion Battery Safety Information	MPC-00006-xx
Intrinsically Safe Li-ion Battery Safety Information	MPD-00024-xx
Battery Charging Guide	MPD-00002-xx
TP9300 User's Guide	MPD-00001-xx
TP9310 User's Guide	MPD-00016-xx
TP9300/TP9400 Service Manual	MPD-00004-xx

Always get the latest issue of a manual from the Tait support website. Also available on the website are software release notes, and technical notes (TNs) which provide technical details not yet in the manuals, or solve any problems that may have arisen.

Product Codes

The product code (T03-xxxxx-xxxx or TP93xxxxxx-xx) printed on a radio label identifies both the radio model and the configuration of that particular radio. Item codes for batteries and chargers are included in the relevant chapters, but this manual does not list all possible radio product codes. For a detailed explanation of product codes and how to interpret them, please refer to the TP9300/TP9400 Service Manual (MPD-00004-xx).

Publication Record

Issue	Date	Description
11	July 2023	Added physical dimensions for the Tait single charger, and the Tait six-way charger.
10	June 2021	Information added for: High Capacity Battery updates added. Voltage + current limit specs for ACC PWR pin added. Updated table header Gens Specs section to include correct battery type.
9	December 2020	Information added for: <ul style="list-style-type: none"> Updated specs for conventional mode under "Number of Networks, Zones, Channels and Groups", "Operational Features" and "Current Consumption".
8	March 2019	Information added for: <ul style="list-style-type: none"> HK band
7	December 2017	Information added for: <ul style="list-style-type: none"> C0 band Updated to include new non-IS/Ni and IS/Ni vehicle chargers.
6	March 2017	Information added for: <ul style="list-style-type: none"> L3-band new intrinsically safe desktop charger and multicharger. Updated " Number of Networks, Zones, Channels and Groups " and added TP9310 information. Changed IP67 to IP68 for non-IS/Ni radios. Minor corrections and additions.
5	November 2016	Information added regarding the transmit band receiver frequency ranges. These have been updated: Transmit frequency range: 757-870MHz Receiver frequency range: 757-776MHz; 850-870MHz.

Regulatory Requirements and Industry Standards

Regulatory Requirements

TP9300 radios meet and exceed the following **regulatory requirements** (where applicable):

- CFR Title 47 Part 15
- AS4295
- EN 300 086¹
- EN 300 113¹
- EN 300 219¹
- EN 301 489¹
- EN 62368¹
- RSS-119
- TIA/EIA-603/603-E

¹ A regulatory requirement issued by ETSI. ETSI requirements do not apply to radios operating in the 700/800/900MHz frequency bands.

Intrinsically Safe (IS) and Non-Incendive (NI) radios and batteries are certified by a third party to be safe to use in particular hazardous locations, or in potentially explosive atmospheres.

Certification



IS/NI certification applies only while the product is used in accordance with the instructions in the radio User's Guide.

TP9300 IS/NI radios meet the following ratings:

- Class I, Zone 1, AEx ib IIC T4 Gb $-20^{\circ}\text{C} \leq \text{Ta} \leq +50^{\circ}\text{C}$ (AEx)
- Class I, Zone 1, AEx ib IIC T3 Gb $-20^{\circ}\text{C} \leq \text{Ta} \leq +60^{\circ}\text{C}$ (AEx)
- Class I, Zone 1, AEx ib IIA T4 Gb $-20^{\circ}\text{C} \leq \text{Ta} \leq +50^{\circ}\text{C}$ (AEx)
- Class I, Zone 1, AEx ib IIA T3 Gb $-20^{\circ}\text{C} \leq \text{Ta} \leq +60^{\circ}\text{C}$ (AEx)
- Class I, Division 2, Group D, T4 Gb $-20^{\circ}\text{C} \leq \text{Ta} \leq +50^{\circ}\text{C}$ (AEx and Canada)
- Class I, Division 2, Group D, T3 Gb $-20^{\circ}\text{C} \leq \text{Ta} \leq +60^{\circ}\text{C}$ (AEx and Canada)
- Class I, Division 2, Group A, B, C, D, T4 Gb $-20^{\circ}\text{C} \leq \text{Ta} \leq +50^{\circ}\text{C}$ (AEx and Canada)
- Class I, Division 2, Group A, B, C, D, T3 Gb $-20^{\circ}\text{C} \leq \text{Ta} \leq +60^{\circ}\text{C}$ (AEx and Canada)
- Class II, Division 2, Group E, F, G (USA and Canada)
- Class III, Division 1 (USA and Canada)
- Ex ib IIC T4 Gb $-20^{\circ}\text{C} \leq \text{Ta} \leq +50^{\circ}\text{C}$ (Canada and IECEx)
- Ex ib IIC T3 Gb $-20^{\circ}\text{C} \leq \text{Ta} \leq +60^{\circ}\text{C}$ (Canada and IECEx)

- Ex ib IIA T4 Gb $-20^{\circ}\text{C} \leq \text{Ta} \leq +50^{\circ}\text{C}$ (Canada and IECEx)
- Ex ib IIA T3 Gb $-20^{\circ}\text{C} \leq \text{Ta} \leq +60^{\circ}\text{C}$ (Canada and IECEx)
- Ⓢ II 2 G Ex ib IIC T4 Gb $-20^{\circ}\text{C} \leq \text{Ta} \leq +50^{\circ}\text{C}$ (ATEX)
- Ⓢ II 2 G Ex ib IIC T3 Gb $-20^{\circ}\text{C} \leq \text{Ta} \leq +60^{\circ}\text{C}$ (ATEX)
- Ⓢ II 2 G Ex ib IIA T4 Gb $-20^{\circ}\text{C} \leq \text{Ta} \leq +50^{\circ}\text{C}$ (ATEX)
- Ⓢ II 2 G Ex ib IIA T3 Gb $-20^{\circ}\text{C} \leq \text{Ta} \leq +60^{\circ}\text{C}$ (ATEX)

defined in the following standards:

- ANSI/ISA-12.12.01-2015
- CAN/CSA-C22.2 No. 213-15
- ANSI/UL 60079-0
- ANSI/UL 60079-11
- CAN/CSA-C22.2 No. 60079-11:14
- CAN/CSA-C22.2 No. 60079-0:15
- EN 60079-0:2012/A11:2013
- EN 60079-11:2012
- IEC 60079-0:2017 7th edition
- IEC 60079-11:2011 6th edition

TP9300 IS/NI radios have the following certificates:

Radio:

- MET E113958
- TÜV 15 ATEX 7792X
- IECEx ITA 15.0015S

Battery:

- TÜV 15 ATEX 7791X
- IECEx ITA 15.0009X



For more information on TP9300 IS/NI radios, refer to the Safety and Compliance Information for Intrinsically Safe Radios (MPD-00013-xx for ATEX and IECEx certification, and MPD-00027-xx for AEx, Ex, and non-incendive certification) available on the Tait support website, <http://support.taitradio.com>.

TP9300 radios also meet and exceed **industry standards** that include:

- Relevant sections of TIA-603-E (Land Mobile FM or PM Communications Equipment Measurement and Performance Standards)
- MIL-STD 810 G (Environmental Engineering Considerations and Laboratory Tests, see also "[Environmental](#)" on page 26)

TIA standards are adopted by TIA in accordance with the American National Standards Institute (ANSI) patent policy.

For applicable Ingress Protection (IP) ratings and military standards, as well as details of the applicable ESD standard, see ["Environmental" on page 26](#).

Quality Assurance Tait is an ISO9001: 2000 and ISO14001: 2004 certified supplier.

Vocoder TP9300 radios use AMBE+2™ voice coding technology.

Performance Figures

TP9300 specifications were derived by measuring **typical performance** and then averaging that measurement across multiple points in each RF band.

In contrast, all figures quoted as regulatory requirements are **guaranteed minimum performance** figures for equipment operated at standard room temperature, +71.6°F to +82.4°F (+22°C to +28°C) and standard test voltage (7.5VDC).

Performance figures quoted as ‘typical’ are generally better than performance figures quoted as ‘guaranteed minimum’.

Definition of NB and WB

The terms ‘narrow bandwidth’ and ‘wide bandwidth’ are used as follows:

Term	Abbreviation	Channel spacing	Modulation 100% deviation
Narrow bandwidth	NB	12.5kHz/15kHz	±2.5kHz
Wide bandwidth	WB	25kHz/30kHz	±5.0kHz

Frequency Bands

Tait uses a unique alpha-numeric code to represent each frequency band. The frequency codes currently used with the TP9300 series of radios are listed below. These codes are used throughout this manual.

Frequency code	Frequency band
B1	136MHz to 174MHz
C0 ^a	174MHz to 225MHz
G1	320MHz to 380MHz
HB ^{bc}	380MHz to 470MHz
HK ^c	378MHz to 470MHz
H5 ^c	400MHz to 470MHz
H7 ^c	450MHz to 520MHz
K5 ^d	757MHz to 870MHz (Tx) 757MHz to 776MHz (Rx) 850MHz to 870MHz (Rx)
L3 ^a	896MHz to 941MHz (Tx) 935MHz to 941MHz (Rx)

- a. Not for IS/NI radios
- b. IS/NI radios only
- c. HB, HK, H5- and H7-band radios are also approved for operation on the Australia and New Zealand Citizens Band frequencies (476.425 to 477.4125MHz). Citizens Band performance limits apply to radios used in this band.
- d. Supports 700 A-Block frequencies 757-758MHz.

Australia and New Zealand Citizens Band

AS/NZS 4365 deals with the use of frequencies in the 476.425 to 477.4125MHz band. Products capable of operating in this band have been approved for operation in the UHF Citizens Band Radio Service which is licensed in Australia by the ACMA Radiocommunications (Citizens Band Radio Stations) Class Licence and in New Zealand by the MBIE General User Radio Licence for Citizens Band Radio. Operation is subject to conditions contained within those licences.

Repeaters operate by receiving a transmission on one channel and re-transmitting it on another. Operators are required to avoid using local repeater input channels, which will be in the range of 31 to 38 (and 71 to 78 when authorized), unless it is intended to use the repeater facility, and to avoid using local repeater output channels, which will be in the range 1 to 8 (and 41 to 48 when authorized), at any time. Operators must always listen in on a channel (or observe a channel-busy indicator) to ensure it is not already being used before transmitting.

No voice transmissions are permitted on data channels 22 and 23. Equipment meeting this standard will inhibit voice operation on channels 22 and 23.

Operators must be aware of the consequences of narrowband (2.5kHz deviation) transmissions being received on older wideband equipment, and wideband (5.0kHz deviation) transmissions being received on newer narrowband equipment. They should also be aware of the possibility of interference due to older equipment being operated on channels adjacent to new narrowband channels. The list of currently authorized channels can be obtained from the ACMA website in Australia and the MBIE website in New Zealand.

In Australia:

- Except in an emergency, a CB transmitter must not be operated on UHF channels 5 and 35.
- Channel 11 is the customary calling channel for establishing communications.
- Channel 40 is the customary road vehicle channel.

FCC Narrowbanding Regulations

The following information applies to all radios, not just to those sold in countries where FCC regulations apply.

From 1 January 2013 it is an FCC requirement that land mobile radio systems must not operate channels with a bandwidth greater than 12.5kHz in the 150–174MHz and 421–470MHz frequency bands. From this date all radios will be supplied with firmware that requires a software feature license to operate a medium or wide bandwidth channel in these frequency bands.

The 20/25kHz Unrestricted Wideband feature license is available to any customer who is not subject to the relevant FCC regulations, or who has an FCC waiver. Note that this feature license is also required to operate a medium or wide bandwidth channel on the spot frequencies which are exempt from the FCC requirement:

- 152.0075, 157.450, 152.480, 157.740 and 158.460MHz in the 150–174MHz frequency band
- 462.750, 462.775, 462.800, 462.825, 462.850, 462.875, 462.900, 462.925, and 465MHz in the 421–470MHz frequency band.

To obtain the feature license, or for more information about it, contact your regional Tait office.

2 Receiver Specifications

This chapter compares the performance of the receiver in a TP9300 radio with receiver requirements specified by ETSI and TIA.

Where an ANSI/TIA or ETSI EN 300 113 test method was used to measure TP9300 performance, this is indicated in parentheses. Where the ETSI test method EN 300 086-1 was used, no test method is named. Please see also the footnotes to the tables.

Notice The TP9300 specifications in this manual are typical performance figures that are intended only to provide guidance. They are subject to change without notice and should not form part of any contract. To establish whether the radio meets the regulatory requirements that apply to you, please contact your regional Tait office.

For important information about how radio performance figures were derived, see [Chapter 1 Preface](#).

Analog

Parameter	Compliance limit	Measured performance		
	All bands ^a	B1, C0	G1, HB ^b , HK, H5, H7	K5, L3
Adjacent channel selectivity				
NB channel ^c WB channel	> 60dB > 70dB	65dB 74dB		n/a ^d
Adjacent channel selectivity (TIA/EIA603 one-tone test method)				
NB channel WB channel	> 50dB > 60dB	65dB 74dB		63dB 72dB
Audio distortion at rated audio (TIA-603-E)				
	< 2%	1.5%		
Audio response (TIA-603-E)				
	+1dB, -3dB	+0.5dB, -2.5dB		
Blocking				
	> 84dB	> 110dB	> 100dB	n/a
Frequency stability (TIA-603-E)				
	±2.5ppm	±0.5ppm		
Intermodulation rejection				
NB channel WB channel	> 65dB > 65dB	66dB 67dB	68dB 69dB	n/a
Intermodulation rejection (TIA-603-E)				
NB channel WB channel	> 70dB > 70dB	75dB 75dB	77dB 77dB	75dB 75dB
Rated audio (TIA-603-E)				
Non-IS/NI radios	0.5W into external 16Ω load			
IS/NI radios	0.5 W into internal 16 Ω load 0.4W into external 24Ω load			

Parameter	Compliance limit	Measured performance (continued)		
	All bands ^a	B1, C0	G1, HB ^b , HK, H5, H7	K5, L3
Internal speaker rating				
		2W		
Hum and noise (TIA-603-E)				
NB channel	34 dB	40 dB		
WB channel	40 dB	45 dB		
Sensitivity				
NB channel	< -107 dB	-116 dBm	-118 dBm	n/a
WB channel	< -107 dB	-118 dBm	-120 dBm	
Sensitivity ^e (TIA-603-E)				
NB channel	< -116 dBm (0.35 μV)	-120 dBm (0.22 μV)		
WB channel	< -116 dBm (0.35 μV)			
Spurious response rejection (TIA-603-E)				
NB channel	> 70 dB	80 dB	76 dB	70 dB ^f
WB channel	> 70 dB	80 dB	76 dB	70 dB ^f

a. See "Frequency Bands" on page 11.

b. IS/NI radios only.

c. See "Definition of NB and WB" on page 11.

d. Not applicable.

e. 12 dB SINAD.

f. 1/2-IF spurious response degrades at the edges of the band.



Sensitivity, distortion, and signal-to-noise figures are for standard operating conditions that include audio de-emphasis.

Digital

Parameter	Compliance limit	Measured performance		
	All bands ^a	B1, C0	G1, HB ^b , HK, H5, H7	K5, L3
Sensitivity ^c (EN 300 113)				
	< -110dBm	-119dBm	-120dBm	
Selectivity (EN 300 113)				
	60dB	62dB		60dB
Intermodulation rejection (EN 300 113)				
	65dB	65dB	67dB	70dB
Spurious response rejection (EN 300 113)				
	> 70dB	76dB	71dB	70dB ^d
Co-channel rejection (EN 300 113)				
	-12dB	-9dB	-8.5dB	-9dB
BER floor (EN 300 113)				
	10 ⁻⁴	0 bit errors		
Blocking (EN 300 113)				
	> 84dB	> 105dB	> 95dB	> 100dB

a. See ["Frequency Bands" on page 11](#).

b. IS/NI radios only.

c. 1% BER.

d. 1/2-IF spurious response degrades at the edges of the band.

3 Transmitter Specifications

This chapter compares the performance of the transmitter in a TP9300 radio with transmitter requirements specified by ETSI and TIA.

Where an ANSI/TIA or ETSI EN 300 113 test method was used to measure TP9300 performance, this is indicated in parentheses. Where the ETSI test method EN 300 086-1 was used, no test method is named. Please see also the footnotes to the tables.

This equipment is compatible with the emissions listed in the following table.

Notice Some emission designators may not apply in all regions. Not all models support all emission designators. Contact your regional Tait office for details.

Emission Designator	Common Name	Modulation Scheme	Operating Modes
11K0F3E	analog voice	analog FM	NB voice
16K0F3E	analog voice	analog FM	WB voice
6K60F2D	FFSK data	FFSK	NB data - 1200 bps
7K80F2D	FFSK data	FFSK	NB data - 2400 bps
9K60F2D	FFSK data	FFSK	WB data - 1200 bps
10K8F2D	FFSK data	FFSK	WB data - 2400 bps
7K60FXD	2-slot DMR	4FSK	data/control channel
7K60FXW	2-slot DMR	4FSK	digital voice/data/ control channel
7K60F7DDT	2-slot DMR	4FSK	digital voice
7K60F7EDT	2-slot DMR	4FSK	digital data
7K60F7DDN	2-slot DMR	4FSK	digital voice
7K60F7EDN	2-slot DMR	4FSK	digital data

Notice The TP9300 specifications in this manual are typical performance figures that are intended only to provide guidance. They are subject to change without notice and should not form part of any contract. To establish whether the radio meets the regulatory requirements that apply to you, please contact your regional Tait office.

For important information about how radio performance figures were derived, see [Chapter 1 Preface](#).

Analog

Parameter	Compliance limit	Measured performance					
	All bands ^a	B1	C0	G1	HB ^b , HK, H5	H7	K5, L3
Audio distortion at 1 kHz with 60% modulation ^c							
	< 2.5%	0.6%					
Audio response ^c							
	+1 dB, -3 dB	+0.5 dB, -2.5 dB					+0.5 dB, -1.5 dB
Conducted emissions							
< 1 GHz	< -36 dBm	-38 dBm	< -40 dBm	-38 dBm	-45 dBm	n/a ^d	
> 1 GHz	< -30 dBm	-40 dBm	< -40 dBm	-40 dBm	-41 dBm		
Conducted emissions (TIA-603-E)							
	> 57 dBc	75 dBc					73 dBc
FM hum and noise (TIA-603-E)							
NB channel ^e	> 34 dB	47 dB	48 dB	47 dB	49 dB	44 dB	
WB channel	> 40 dB	48 dB	53 dB	52 dB	53 dB	50 dB	
Adjacent channel power (TIA-603-E)							
NB channel	60 dBc	65 dBc	65 dBc	65 dBc	65 dBc	65 dBc	
WB channel	70 dBc	74 dBc	77 dB	76 dBc	77 dBc	73 dBc	
Adjacent channel power (EN 300 086)							
NB channel	60 dBc	66 dBc	67 dBc	73 dBc	70 dBc	72 dBc	
WB channel	60 dBc	74 dBc	76 dBc	77 dBc	75 dBc	74 dBc	

Parameter	Compliance limit	Measured performance (continued)					
	All bands ^a	B1	C0	G1	HB ^b , HK, H5	H7	K5, L3
Wideband noise [all values dBc/Hz]							
100kHz offset	n/a (Tait in-house test only)	-130	-130	-134	-134	-139	-132
1MHz offset		-145	-145	-146	-140	-145	-138
1.5MHz offset		-149	-147	-149	n/a	n/a	n/a
4MHz offset		n/a	n/a	n/a	-139	-144	n/a
12MHz offset		n/a	n/a	n/a	n/a	n/a	-141
10MHz offset		-154	-152	-155	-138	-143	n/a
45MHz offset	n/a	n/a	n/a	n/a	n/a	-149	
Modulation limiting ^c							
NB channel	±2.5kHz	±2.2kHz					
WB channel	±5.0kHz	±4.4kHz					
Radiated emissions							
<1GHz	< -36dBm	< -46dBm					n/a
>1GHz	< -30dBm	< -40dBm					
Radiated emissions (TIA-603-E)							
	57dBc	> 90dBc					> 84dBc
RF power output ^{cf}							
High		5W		4W		3W ^g	
Medium		3W		2.5W		2.5W	
Low		2W		2W		2W	
Very low		1W		1W		1W	

a. See ["Frequency Bands" on page 11](#).

b. IS/NI radios only.

c. EN 300 086-1 and TIA-603-E test methods.

d. Not applicable.

e. See ["Definition of NB and WB" on page 11](#).

f. IS/NI radios may have different, imposed power limits.

g. K5 IS/NI radios limited to 2.5W

Digital

Parameter	Compliance limit	Measured performance				
	All bands ^a	B1	C0	G1	HB ^b , HK, H5, H7	K5, L3
Adjacent channel power ratio (EN 300 113)						
	60dBc	62dBc				
Transient adjacent channel power ratio (EN 300 113)						
	50dBc	57dBc	60dBc	62dBc	59dBc	50dBc

a. See ["Frequency Bands" on page 11](#).

b. IS/NI radios only.

4 General Specifications

This chapter provides general specifications for the TP9300 portable radios, TP9300 Intrinsically Safe (IS) and Non-Incendive (NI) portable radios, and for the batteries and chargers used with them.

Figure 4.1 TP9300 (16-key radio) dimensions and user interface

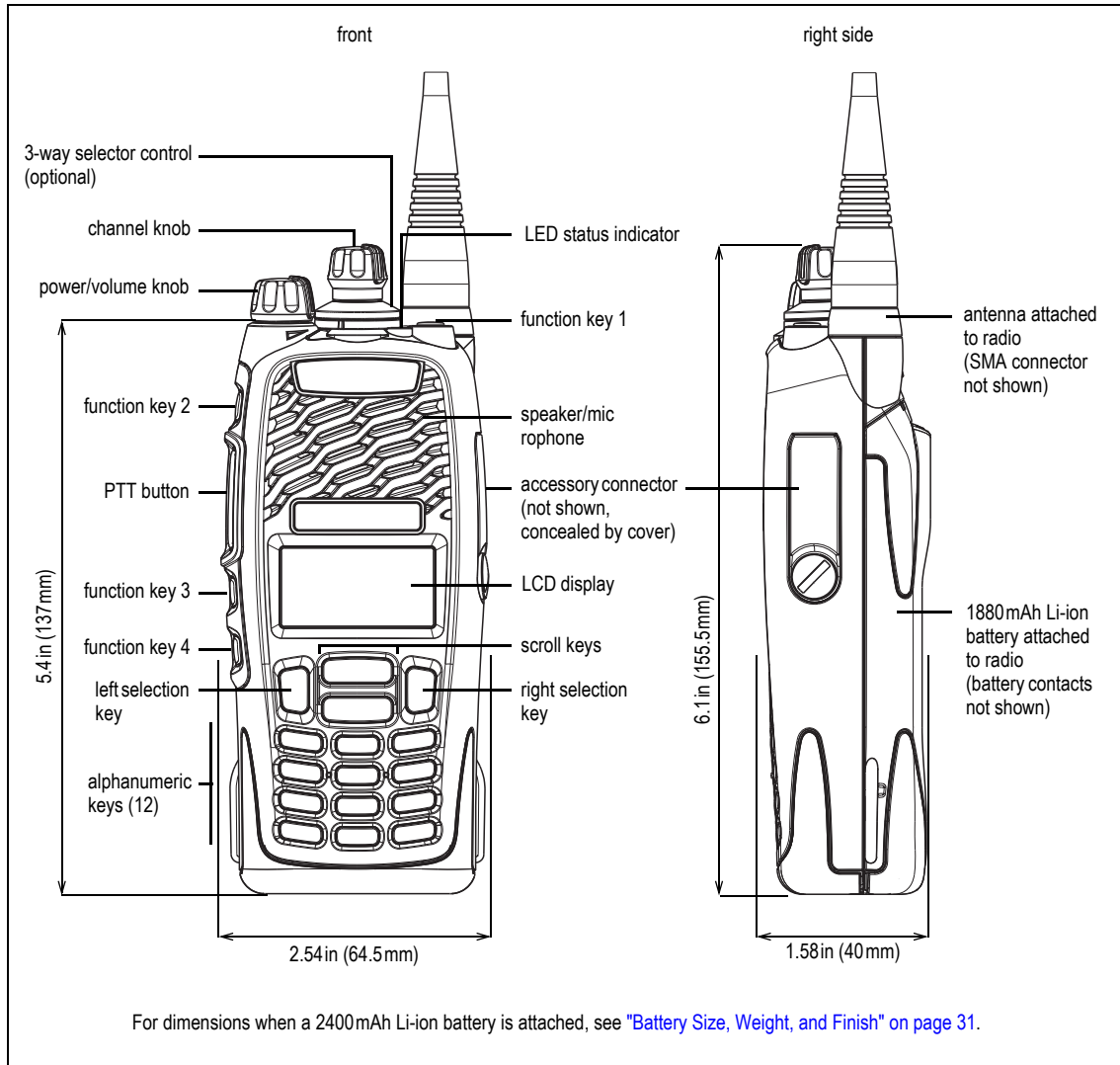

Radio Specifications

This section lists general radio specifications.

- For radio compliance specifications, see ["Regulatory Requirements and Industry Standards" on page 8.](#)
- For receiver performance specifications, see [Chapter 2 Receiver Specifications.](#)
- For transmitter performance specifications, see [Chapter 3 Transmitter Specifications.](#)



The product code printed on the radio label identifies both the radio model and the configuration of that particular radio. For an explanation of product codes, please refer to the TP9300/TP9400 Service Manual (MPD-00004-xx).

User Interface

For the location of the keys, see [Figure 4.1 page 22.](#)

Connectors	
Accessory connector	Standard interface for compatible accessories, on the right side of the front panel (see "Accessory Connector" on page 25); when not in use, the nine contacts are protected by a plastic cover (which should remain on the radio when the connector is not in use)
Battery contacts	Two self-cleaning swipe contacts on the rear panel
Antenna connector	Stainless steel SMA connector
Display ^a	128x60 pixel backlit LCD screen, menu driven
Function keys	Four programmable keys: three silicone rubber keys on the left of the front panel and a colored key, sometimes called the 'emergency key', on the top
Keypad ^a	Two scroll keys, an enter/menu key, and a clear/back key; 12 alpha-numeric keys in some models
Knobs	
3-way selector (optional) ^a	Plastic knob
Channel knob	Textured rubber knob
Volume knob	Textured rubber knob
LED status indicator	Opaque silicone rubber lens that can be lit green, amber, or red
Press To Talk (PTT) button	Large silicone rubber button on the left of the front panel
Speaker-microphone	Combined speaker and microphone inside front panel; speaker with 8Ω impedance for non-is radios and 16Ω for IS/NI radios

a. Not fitted to TP9310.

Radio Size, Weight, and Finish

	1880 mAh 'Slimline' T03-00011-Axxx	2400mAh 'Performance' T03-00011-Cxxx	3300mAh 'High Capacity' T03-00011-Exxx	2300mAh IS/NI T03-22001-Axxx
Size (WxH ^a xD)	2.4in x 5.4in x 1.58in (61mm x 137mm x 40mm)	2.4in x 5.4in x 1.77in (61mm x 137mm x 45mm)	2.4in x 5.4in x 1.77in (61mm x 137mm x 45mm)	2.4in x 5.4in x 1.77in (61mm x 137mm x 45mm)
Weight ^b	12.13oz (344g)	13.76oz (390g)	14.22 (403g)	15.17oz (430g)
Finish, body	Two-shot moulded construction, easy grip, with toughened rubber armor corners			

a. Height measured to base of channel knob.

b. Includes antenna TPA-AN-001 (136-225MHz). For battery dimensions see ["Battery Specifications" on page 31](#).

Accessory Connector

The accessory connector has nine contacts. These are described in the following table. For more information, refer to the TP9300/TP9400 Service Manual (MPD-00004-xx).

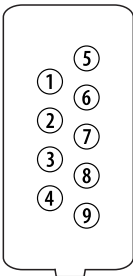
	Pin	Signal name	Description
	1	ACC TXD ^a	Asynchronous serial port. Data direction is from the radio to the PC.
	2	ACC SPKR ⁻	External speaker negative output. Balanced load configuration. (Differential drive with ACC SPKR+.)
	3	ACC GPIO1 ^a	General purpose input/output. Function and direction depends on the radio model.
	4	ACC PWR ^b	Power output. Switched and current-limited supply from the radio to the accessory. Supply is switched off when the radio is powered off.
	5	GND	Ground
	6	ACC PTT ^a	External PTT or button input. Analog signal allows multiplexed buttons in external devices such as speaker-microphones. Two levels are defined for button presses, which creates three inputs to the system on the single wire.
	7	ACC SPRK ⁺	External speaker positive output. Balanced load configuration. (Differential drive with ACC SPKR-.)
	8	ACC MIC ^a	Accessory (auxiliary) microphone input. Electret microphone biasing is provided inside the radio. Dynamic microphones are not supported.
	9	ACC RXD ^a	Asynchronous serial port. Data direction is from the computer to the radio.

a. Safe DC limit: Non-IS/NI radios: -12V (minimum), +12V (maximum);
IS/NI radios: -3.60V (minimum), +4.95V (maximum)

b. Non-IS/NI radios: Output Voltage: 6V (min), 8.6V (max) 7.5V (nominal) Current Limit: 50mA;
IS/NI radios: Output voltage: 3.3V (nominal), Current limit: 10mA (nominal)

Environmental

Frequency stability temperature	-22°F to +140°F (-30°C to +60°C)		
Operating temperature	Non-IS/NI radios:	-22°F to +140°F (-30°C to +60°C) ^a	
	IS/NI radios: T3 T4	-4°F to +140°F (-20°C to +60°C) -4°F to +122°F (-20°C to +50°C)	
Ingress Protection (IP) rating	IP65, IP67, IP68		
Electrostatic Discharge (ESD) standard	International Electrotechnical Commission (IEC) 61000-4-2		
Military standard (MIL-STD)	MIL-STD-810G ^b		
		Method	Procedure
	Low pressure	500.5	2
	High temperature	501.5	1 and 2
	Low temperature	502.5	1 and 2
	Temperature shock	503.5	1
	Solar radiation	505.5	1
	Rain	506.5	1 and 3
	Humidity	507.5	2
	Salt fog	509.5	1
	Dust	510.5	1 and 2
	Immersion	512.5	1
	Vibration	514.6	1
	Shock	516.6	1, 4, 5 and 6

a. For information on battery operating temperature ranges, refer to table 4.2 under "[Expected Shift Life](#)".

b. The TP9300 also meets the equivalent superseded standards MIL-STD-810C, D, E, and F.

See also "[Regulatory Requirements and Industry Standards](#)" on page 8.

Frequencies and Channels

	B1	C0 ^a	G1 ^a , HB ^b , HK, H5 ^a , H7	K5, L3 ^a
Frequency increments				
	2.5kHz, 5kHz, 6.25kHz			
Channel spacing				
NB channel WB channel	12.5 kHz/15kHz 25kHz/30kHz			
Frequency range (MHz), see "Frequency Bands" on page 11				
Frequency stability, see Chapter 2 Receiver Specifications				
IF bandwidth				
NB channel WB channel	9kHz 15kHz			
RF power output (non-IS/NI radios)				
High	5W	5W	4W	3W
Medium	3W	3W	2.5W	2.5W
Low	2W	2W	2W	2W
Very low	1W	1W	1W	1W
RF power output (IS/NI radios with IIA rating)				
High	5W		4W	2.5W
Medium	3W		2.5W	2.5W
Low	2W	N/A	2W	2W
Very low	1W		1W	1W
RF power output (IS/NI radios with IIC rating)				
High	1W		1W	1W
Medium	1W		1W	1W
Low	1W	N/A	1W	1W
Very low	1W		1W	1W

a. Not for IS/NI radios.

b. IS/NI radios only.

Number of Networks, Zones, Channels and Groups

Conventional Mode

	TP9355/TP9360	TP9310
Conventional networks	26	1
Zones	26	3
Channels (simplex or semi-duplex)	1500	48
Scan/vote groups	300 (up to 10 members)	48
Channels per group	50	50

Trunked Mode

	TP9355/TP9360	TP9310
Trunked networks	4 (shared between MPT and DMR)	4
Zone and workgroups	1000 zones, 1000 work functions per zone, organised in a matrix structure	1 zone, 16 workgroups
Talk groups	512	16

Location Services

TTF ^a cold start	<60 seconds ^b
TTF hot start	<10 seconds ^b
Location accuracy	<33 feet (<10 metres) ^b
Mode of operation	non-assisted GPS (autonomous)

a. Time To First Fix.

b. These values are for long-term tracking (95th percentile values >5 satellites visible at a nominal –130dBm signal strength).

Operational Features

	Analog operation	DMR digital operation
Channels: <ul style="list-style-type: none"> • simplex or semi duplex • repeater talkaround option 	<ul style="list-style-type: none"> ✓ ✓ 	DMR Tier 2 ✗
Trunking	MPT 1327	DMR Tier 3
Voting/scanning	✓	✓
Predefined status messaging	✓	✓
GPS	Internal (send and receive position reports), GPS display	Internal (send and receive position reports), GPS display
2-tone signaling format	Decode only	✗
5-tone Selcall	✓	✗
CTCSS signaling format	✓	✗
DCS signaling format	✓	✗
DTMF signaling format	Encode only	✗
MDC1200 signaling format	✓	✗
Security/Encryption	Voice inversion scrambler (standard)	AES (optional) DES (optional) ARC4 (optional)
Emergency <ul style="list-style-type: none"> • Lone Worker inactivity detection • Man down (an additional Lone Worker feature) 	<ul style="list-style-type: none"> ✓ ✓ 	<ul style="list-style-type: none"> ✓ ✓

Current Consumption

	B1	C0	G1, HB ^a , HK, H5, H7	K5, L3
Current consumption				
Receiver squelched	100mA	105mA	105mA	110mA
Receiver (rated audio)	215mA	225mA	225mA	225mA
Transmitter current				
Very low power	1A	0.7A	1A	1A
Low power	1.3A	0.9A	1.3A	1.3A
Medium power	1.5A	1.1A	1.4A	1.4A
High power	1.9A	1.4A	1.8A	1.5A

a. IS/NI radios only.

Current consumption was tested using conventional non-IS/NI radios equipped with the latest radio hardware. All measurements were made in the middle frequencies of each band. Battery voltage was 7.5V, and radios transmitted into a 50Ω load.

Battery Specifications

Observe all safety precautions that relate to the handling of Li-ion batteries.



Warning LI-ION BATTERY. This radio uses a Lithium-ion battery. If the battery is damaged or handled in an unsafe manner, it can cause personal injury and/or damage to property. Read the important safety information in the Li-ion Battery Safety Information document (MPC-00006-xx). The document is on the Tait support website.



Warning LI-ION BATTERY. Do not allow anything to obstruct the vent hole in the battery. If the battery vent is obstructed, the battery may explode, causing personal injury and/or damage to property. Make sure that no customized label attached to the battery or radio will obstruct the battery vent hole.



Warning Use only a Tait-supplied, IS/NI-approved battery or charger with an IS/NI radio. Fitting a battery that is not IS/NI-approved, or using a charger that is not IS/NI-approved, creates a risk of explosion which could cause serious injury or death. Do not charge the battery in a hazardous location. An explosion could cause serious injury or death. For detailed information about IS/NI radios and accessories and how to identify them, refer to the Safety and Compliance Information for Intrinsically Safe Portable Radios (MTA-00013-xx for ATEX and IECEx certification, and MPD-00027-xx for AEx, Ex, and non-incendive certification) provided with the radio.

Battery Size, Weight, and Finish

	1880 mAh 'Slimline' T03-00011-Axxx	2400mAh 'Performance' T03-00011-Cxxx	3300mAh 'High Capacity' T03-00011-Exxx	2300mAh IS/NI T03-22001-Axxx
Size (WxHxD)	2.4 in x 4.7 in x 0.7 in (61 mm x 118 mm x 17 mm)	2.4 in x 4.7 in x 0.8 in (61 mm x 118 mm x 21 mm)		
Weight	4.6 oz (130 g)	6.2 oz (175 g)	6.6 oz (188 g)	6.1 oz (172 g)
Finish	Two-shot molded construction, with toughened rubber armor corners			

Expected Shift Life

The following table shows the expected shift life for a fully charged, healthy Li-ion battery when the radio is used in analog mode, and when the radio is used in DMR digital mode.

-  To maximize battery life and performance, and to charge batteries correctly, follow the instructions provided in the Battery Charging Guide (MPD-00002-xx) supplied with the charger.

Table 4.1 C0, G1 and L3 bands

	1880mAh^a 'Slimline' T03-00011-Axxx	2400mAh^a 'Performance' T03-00011-Cxxx	3300mAh^a 'High Capacity' T03-00011-Exxx	2300mAh^a IS/NI T03-22001-Axxx
Analog mode				
Duty cycle 5 / 5 / 90 ^b	10 hours	13 hours	18 hours	11.5 hours
Duty cycle 5 / 35 / 60 ^c	8 hours	11 hours	15 hours	9.5 hours
DMR TDMA operation				
Duty cycle 5 / 5 / 90	13 hours	17 hours	24 hours	15 hours
Duty cycle 5 / 35 / 60	10 hours	13 hours	19 hours	12 hours

- Figures assume a new rated cell capacity. Shift life numbers represent the radio functioning under the following conditions: correct antenna being used and backlighting is off. Bluetooth and GPS are off. Ambient temperature of 68°F (20°C)
- 5% transmitting, 5% receiving, 90% standby.
- 5% transmitting, 35% receiving, 60% standby.

Table 4.2 B1, HB, HK, H5, H7, K5 bands

	1880mAh^a 'Slimline' T03-00011-Axxx	2400mAh^a 'Performance' T03-00011-Cxxx	3300mAh^a 'High Capacity' T03-00011-Exxx	2300mAh^a IS/NI T03-22001-Axxx
Analog mode				
Duty cycle 5 / 5 / 90 ^b	12 hours	15 hours	21 hours	11.5 hours
Duty cycle 5 / 35 / 60 ^c	9 hours	12 hours	17 hours	9.5 hours
DMR TDMA operation				
Duty cycle 5 / 5 / 90	16 hours	20 hours	27 hours	15 hours
Duty cycle 5 / 35 / 60	12 hours	15 hours	21 hours	12 hours

- Figures assume a new rated cell capacity. Shift life numbers represent the radio functioning under the following conditions: correct antenna being used and backlighting is off. Bluetooth and GPS are off. Ambient temperature of 68°F (20°C)
- 5% transmitting, 5% receiving, 90% standby.
- 5% transmitting, 35% receiving, 60% standby.

Temperature Range for Charging and Operating

	1880mAh 'Slimline' T03-00011-Axxx	2400mAh 'Performance' T03-00011-Cxxx	3300mAh 'High Capacity' T03-00011-Exxx	2300mAh IS/NI T03-22001-Axxx
Operating temperature range	+14°F to +140°F (-10°C to +60°C)	-4°F to +140°F (-20°C to +60°C)	-4°F to +140°F (-20°C to +60°C)	T3: -4°F to +140°F (-20°C to +60°C) T4: -4°F to +122°F (-20°C to +50°C)
Charging temperature range	+41°F to +104°F (+5°C to +40°C)			

Battery Charger Specifications



Warning Explosion hazard! Use only a Tait-supplied, IS/Ni-approved battery or charger with an IS/Ni radio. Fitting a battery that is not IS/Ni-approved, or using a charger that is not IS/Ni-approved, creates a risk of explosion which could cause serious injury or death. Do not charge the battery in a hazardous location. An explosion could cause serious injury or death. For detailed information about IS radios and accessories and how to identify them, refer to the Safety and Compliance Information for Intrinsically Safe Portable Radios (MTA-00013-xx for ATEX and IECEx certification, and MPD-00027-xx for AEx, Ex, and non-incendive certification) provided with the radio.

Use only the following chargers to charge a TP9300 Li-ion battery:

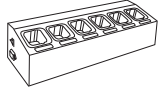
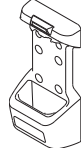
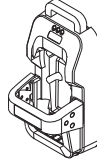
Part number range	Designation	
T03-00012-xxxx	Desktop charger for non-IS/Ni batteries	
T03-22011-Bxxx	Desktop charger for IS/Ni batteries ^a	
T03-00013-xxxx	6-way charger for non-IS/Ni batteries	
T03-22011-Cxxx	6-way charger for IS/Ni batteries	
T03-00014-Axxx	Battery-only vehicle charger for non-IS/Ni batteries ^b	
T03-00014-Bxxx	Vehicle charger for non-IS/Ni batteries ^c	
T03-22011-Dxxx	Vehicle charger for IS/Ni batteries ^c	

a. Desktop charger for IS/Ni batteries T03-22011-Axxx has been discontinued.

b. See the installation instructions (402-00078-xx) for more information.

c. See the installation instructions (402-00105-xx) for more information.



Warning Explosion hazard! Use only a charger for IS batteries (T03-22011-xxxx) to charge a TP9300 IS/Ni Li-ion battery.

Notice To maximize battery life and performance, and to charge batteries correctly, follow the instructions provided in the Battery Charging Guide (MPD-00002-xx) supplied with the charger.

Notice If the radio is attached to the battery while the battery is being charged, the radio must be switched off. If the radio transmits while in the charger, interference from the charger may cause interference to other radio users.

Charge Temperature

A Li-ion battery will charge correctly only when the temperature of the battery and the charger is between +41 °F (+5 °C) and +104 °F (+40 °C).

Charge Times Using Chargers for Non-IS/NI Batteries

	1880mAh 'Slimline' T03-00011-Axxx	2400mAh 'Performance' T03-00011-Cxxx	3300mAh 'High Capacity' T03-00011-Exxx
Typical time to full charge	1.5 hours to 2 hours	2 hours to 2.5 hours	2.5 hours to 3 hours
Maximum time to full charge	2.5 hours	3 hours	4 hours

Charge Times Using Charger for IS/NI Batteries

**Desktop Charger
(T03-22011-Axxx)
(discontinued)**

	1880mAh 'Slimline' T03-00011-Axxx	2400mAh 'Performance' T03-00011-Cxxx	2300mAh IS/NI T03-22001-Axxx	3300mAh 'High Capacity' T03-00011-Exxx
Typical time to full charge	3 to 4.5 hours	4 to 5.5 hours		4.5 to 6 hours
Maximum time to full charge	5.3 hours	6.9 hours	6.3 hours	8 hours

**Desktop Charger
(T03-22011-Bxxx)**

**6-way Charger
(T03-22011-Cxxx)**

**Vehicle Charger
(T03-22011-Dxxx)**

	1880mAh 'Slimline' T03-00011-Axxx	2400mAh 'Performance' T03-00011-Cxxx	2300mAh IS/NI T03-22001-Axxx	3300mAh 'High Capacity' T03-00011-Exxx
Typical time to full charge	2 to 2.5 hours	2.5 to 3.2 hours		3.2 to 4.5 hours
Maximum time to full charge	3 hours	4 hours		5 hours



The chargers for IS/NI batteries replenish batteries at a slower rate than non-IS/NI chargers.

Charger Specifications for Non-IS/NI Batteries

	Desktop charger (T03-00012-xxxx)	6-way charger (T03-00013-xxxx)	Vehicle chargers (T03-00014-Axxx/Bxxx)
Input rating	12V, 2A	100VAC to 250VAC, 50/60Hz, 2.5A	13.8V, 2A
Input range	11.4VDC to 18VDC	85VAC to 264VAC; 120VDC to 370VDC	11.4VDC to 18VDC
Output rating		10VDC, 2.5A	
Charger output (CCCV) ^a	2A, 8.4V		

a. CCCV = Constant Current Constant Voltage

Charger Specifications for IS/NI Batteries

	Desktop charger for IS/NI batteries (T03-22011-Axxx) ^a	Desktop charger for IS/NI batteries (T03-22011-Bxxx)	6-way charger for IS/NI batteries (T03-22011-Cxxx)	Vehicle charger for IS/NI batteries (T03-22011-Dxxx)
Input rating	12V, 2A	12V, 2A	100VAC to 250VAC 50/60 Hz, 1.9A	13.8V, 2A
Input range	11.4VDC to 12.6VDC	11.4VDC to 12.6VDC	85VAC to 264VAC; 120VDC to 370VDC	11.4VDC to 18VDC
Charger output (CCCV) ^b	0.8A, 8.4V	1.6A, 8.4V	1.6A, 8.4V	1.6A, 8.4V

a. Discontinued

b. CCCV = Constant Current Constant Voltage

LED Indicators

The chargers display a red LED when the battery is charging, a green LED when the battery is fully charged, and an amber LED if there is a problem.

Charger Mechanical Dimensions

**Tait single charger
(T03-00012-xxx)**

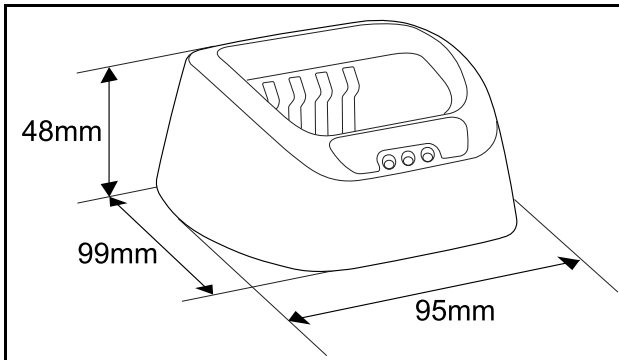

**Tait six-way charger
(T03-00013-xxx)**

