

T02-00061-xxxx Single Remote Head Kits Installation Instructions

The T02-00061-xxxx Single Remote Head Kits can be used to install one control head remotely from the radio body of the TM9300 and the TM9400 mobile radios.

- The T02-00061-1xxx Remote Head Kit provides a complete remote head kit.
- The T02-00061-2xxx Remote Upgrade Kit provides a remote control head interface which is fitted to an existing local control head.
- The T02-00061-3xxx Remote Kit provides a remote interface which can be combined with a radio body and a remote control head (T02-00071-Cxxx) to produce a remote head system.



remote head



remote control head interface

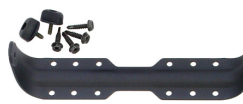

remote U-bracket (incl. screws)



control head interface box
(incl. power cable)



remote cable



remote body interface

The following rules apply for the installation of a remote head:

- A remote cable of up to 20ft (6m) is allowed between the radio body and remote control head.
- A remote cable of up to 98ft (30m) is allowed between the radio body and control head interface box.
- A remote cable of up to 20ft (6m) is allowed between the control head interface box and remote control head.

The kits contain the following parts:

Description	T02-000061-1xxx remote kits	T02-000061-2xxx remote upgrade kits	T02-000061-3xxx single remote upgrade kits
remote head	1	0	0
remote control head interface	0	1	0
remote U-bracket	1	1	0
control head interface box ^a	0 or 1	0 or 1	0 or 1
remote cable ^{ab}	1 or 2	1 or 2	1 or 2
remote body interface	1	1	1

a. Kits for remote head installations < 20ft (6m) contain one remote cable and no control head interface box. Kits for remote head installations > 20ft (6m) contain two remote cables and one control head interface box

b. Remote cable lengths vary between kits.

Installation Precautions



Do not combine or swap items from different kits or use remote items from TM8200 or TM9100 mobile radios. There are several remote interfaces and cables available that are similar in appearance, but are configured differently and are not always compatible.



Warning Mount the remote U-bracket with the remote head and the U-bracket with the radio body securely. These units must not break loose in the event of a collision. Unsecured radio units are dangerous to the vehicle occupants.



Warning When drilling holes in a vehicle, check that drilling at the selected points will not damage existing wiring, fuel tanks, fuel lines, brake pipes or battery cables.

Notice This equipment contains devices that are susceptible to static charges. The procedures outlined in this installation guide should therefore be carried out in a static-safe environment. You can obtain information on antistatic precautions and the dangers of electrostatic discharge (ESD) from standards such as ANSI/ESD S4.1 or BS EN 61340-5. The Electrostatic Discharge Association website is <http://www.esda.org/>.

Planning the Installation

The following diagram summarizes how the components are installed.

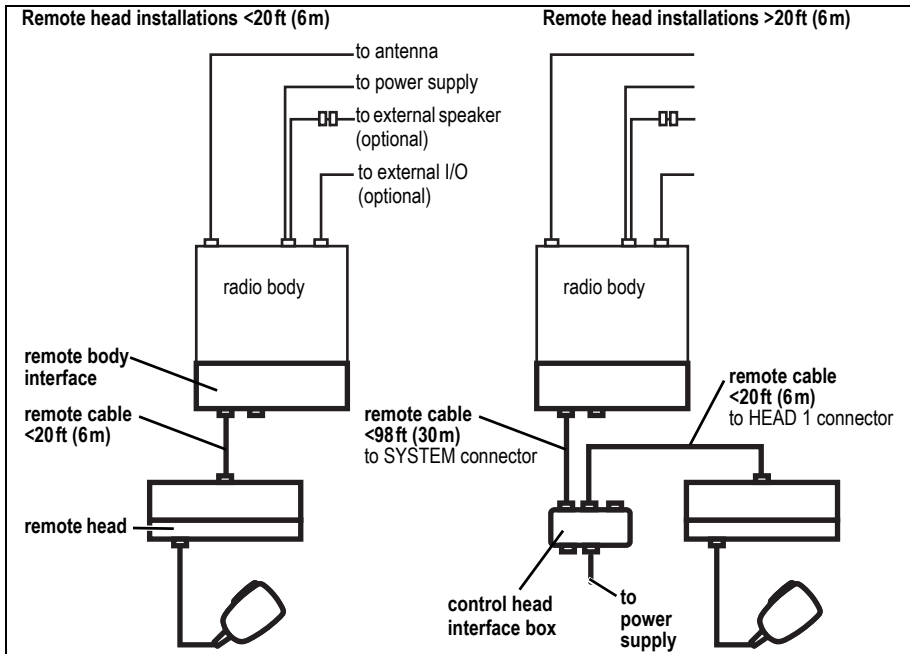

Lay out all cables as shown in this diagram. Determine the best mounting position for all components, at distances less than the length of each cable used.

Preparing the Components for Installation

1 Remove an existing local control head from the radio body (if necessary).

Notice During this procedure, take care that the control head seal is not damaged. Damage to this seal reduces environmental protection.



On the underside of the radio, two lever points are indicated on the radio body by a dot-dash-dot pattern (○ — ○). The lever point is between the control head seal and the control head seal.

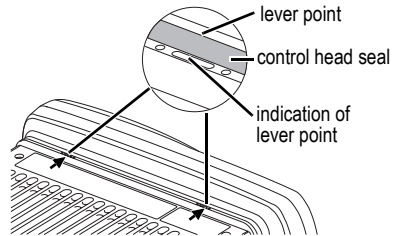

- At either of the lever points, insert a 3/16 inch (5 mm) flat-bladed screwdriver between the control head and the control head seal.
- Use the screwdriver to lift the control head off the snap feature, then repeat in the other position.
- Unplug the control head loom from the radio body.
- The control head is now separate from the radio body.

2 Install the remote body interface onto the radio body.

- Screw the earthing tag ① onto one of the screw bosses on the radio chassis.
- Plug the body-interface loom ② onto the control head connector.
- Insert the bottom edge of the remote body interface ③ onto the two clips in the front of the radio chassis, then snap into place.
- Remove the bung ④ covering the left RJ45 connector. The remote cable will plug into this connector once the installation is complete.

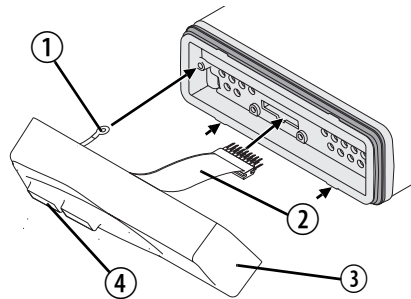

Notice The RJ45-cavity bung must be installed in the unused RJ45 cavity at all times. This ensures that the remote body interface is sealed against water, dust and other environmental hazards.

3 Remove the adaptor flange from the existing control head (remote head upgrade kit only).

- a Undo the two Torx T-20 screws on the adaptor flange of the control head, and remove the adaptor flange.
- b Unplug the control head loom.

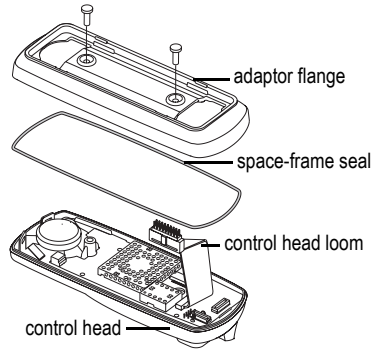

The adaptor flange and control head loom are not used for the remote control head installation. Keep the two screws for step 5b.

4 Optional: Change the orientation of the remote head.



The remote control head interface is configured for installation with the RJ45 socket facing downwards (U-bracket below control head). If the RJ45 socket is required to face upwards (control head hanging from U-bracket), the control head interface loom must be moved to the opposite connector, so that the loom can reach the control head connector when the control head interface is rotated.

- a If the remote head is assembled, undo the two Torx T-20 screws on the control head interface of the remote head, and remove the control head interface.
- b Undo the seven Torx T-10 screws on the control head interface board, and remove the board from the interface panel.
- c Change the control head interface loom to the opposite connector.
- d Reinstall the control head interface board.

5 Fit the remote control head interface to the control head (if necessary).

- a Plug the control head interface loom into the connector on the control head.

Notice When fitting the remote control head interface to the control head, be careful not to damage the space-frame seal.

- b Use the two screws from steps 3a or 4a to fit the remote control head interface to the control head through the two screw holes at the rear of the control head interface. Use a Torx T20 torque-driver to tighten the two screws to 18lb·in (2.0N·m).

6 Configure the control head interface box link.

- a Remove the seal from the top of the control head interface box.
- b Check that the link is set to **LOCAL POWERED**. If necessary, use small long-nose pliers to change the link.
- c Replace the seal.

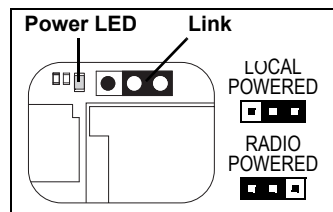

Installation

1 Install the cables, control head interface box, and U-brackets.



Warning When drilling holes in a vehicle, check that drilling at the selected points will not damage existing wiring, fuel tanks, fuel lines, brake pipes or battery cables.

Notice The control head interface box does not provide IP54 protection. Choose a mounting position away from water, dust, and other environmental hazards.

Notice If precise positioning is required, predrill \varnothing 1/8 inch (3 mm) pilot holes for the self-drilling screws. Reduce the hole size in metal that is less than 1/32 inch (1 mm) thick.

- a Drill any holes required for cables and install suitable grommets or bushings in the holes.
- b Drill any holes required for installing the control head interface box and U-brackets.



Warning Mount the remote U-brackets for remote head and radio body securely. These units must not break loose in the event of a collision. Unsecured radio units are dangerous to the vehicle occupants.

Notice Make sure that the U-brackets are not distorted when the screws are tightened.



For more information on installation procedures, refer to the radio's installation guide (available from the Tait Technical Support website <http://support.taitradio.com>).

- c Mount or re-mount the control head interface box and U-brackets for the radio body and remote head using the screws and washers provided (or use another preferred method for the radio body, such as slide-in cradle or security bracket).

2 Connect the cables and install the radio body and remote head.

- a Connect the antenna and power cables to the rear of the radio body.
- b Position the radio body in the U-bracket so that the holes in the U-bracket line up with the holes in the radio chassis.
- c Screw the radio into position using the four thumb screws.
- d Connect the remote cable to the left RJ45 connector of the remote body interface.

Notice The remote cable grommets must be installed whenever remote cables are plugged into the RJ45 sockets. When installed, the grommets prevent damage to the RJ45 sockets when there is movement of the remote cable, and ensure the radio and remote head is sealed against water, dust and other environmental hazards.

Notice The RJ45-cavity bung must be installed in the unused RJ45 cavity at all times. This ensures that the remote body interface is sealed against water, dust and other environmental hazards.

- e Slide the grommet along the remote cable and push two adjacent corners of the grommet into the RJ45 socket cavity.

- f Squeeze the grommet and push the remaining corners into position.
- g Check that the grommet is seated correctly in the cavity.
- h If a control head interface box is used, connect the remote cables to the control head interface box.
- i Connect the remote cable to the remote head.
- j Screw the remote head into position in the U-bracket using the two thumb screws provided.

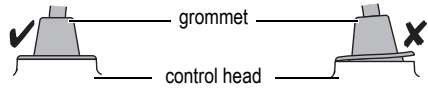

3 Connect power to the control head interface box (if used).

Select from **one** of the following power options:

Notice Make sure the chosen power option is disconnected at the source.

- Use the power cable assembly supplied to connect the power connector (see right) to a power source such as a vehicle battery (refer to the radio installation guide), or a T02-00036-xxxx power supply.
- Use a power adaptor rated to provide 10.8–16V DC at >2A to connect the 2.5mm DC jack to a power source

Pin	Signal	Function
1	AGND	Earth return
2, 3	N/C	Not used
4	+13V8BATT	DC power input (10.8V to 16.0V)

i Power can be permanently applied to the control head interface box without affecting current drain. The control head will only power on when power is applied to the radio system via the radio body.

4 Check the installation.

Apply power to the radio and the control-head interface box. If the radio does not power on, press the On/Off key on the control head.

More Information

Refer to your radio provider for more information about this product.

Dimensions (not to scale)

Remote U-bracket (with remote head installed)

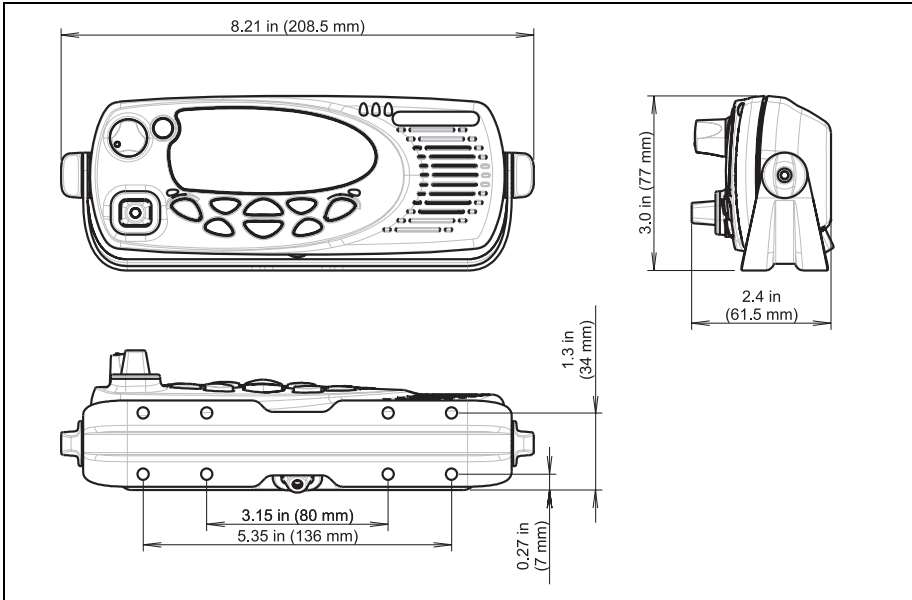

Control Head Interface Box

