

# TM9400 P25 Mobile Radios User's Guide

MMB-00003-08· Issue 7 · May 2021





# Contents

	<b>For your safety.....</b>	<b>9</b>
	<b>Menu maps.....</b>	<b>18</b>
<b>1</b>	<b>About this guide .....</b>	<b>20</b>
	Safety warnings used in this guide .....	20
	Related documentation.....	21
<b>2</b>	<b>Getting started .....</b>	<b>22</b>
	About P25 digital radios.....	23
	Lack of static noise.....	23
	Coverage.....	23
	P25 phase 2 operation .....	23
	About the radio controls.....	24
	About the keypad microphone.....	25
	About the hand-held control head .....	26
	Understanding the radio display .....	27
	Radio display icons .....	27
	Understanding the radio indicators.....	28
	Status indicators.....	28
	Audible tones.....	29
	Voice annunciation .....	30
	Using function keys to access frequently used features.....	31
	Viewing the function key settings .....	31
	Navigating the radio's menus .....	32
	Using the Main menu .....	32
	Accessing frequently used menus.....	33
<b>3</b>	<b>Basic operation .....</b>	<b>35</b>
	Turning the radio on and off .....	36
	Security lock on power-up feature .....	36
	Adjusting the speaker volume .....	37
	Activating the external speaker .....	37
	Locking and unlocking the keypad .....	38
	Selecting a zone .....	39
	Selecting a channel .....	39
	Limiting call time .....	40
	Checking recent calls .....	41
	Setting and viewing the radio's time and date .....	42
	Updating the radio over the air .....	42
<b>4</b>	<b>Operating in conventional mode .....</b>	<b>43</b>
	Making a call.....	44
	Making an individual call.....	44

Understanding talkgroups .....	45
Making a local call .....	47
Connecting to a telephone network.....	48
Making an emergency call.....	50
Sending a status message .....	50
Receiving calls .....	51
Identifying the talking party or caller.....	51
Receiving a two-tone call .....	52
Communicating directly with other radios.....	53
Checking that the channel is clear .....	54
Turning monitor on and off .....	54
Using the radio in different repeater areas .....	55
Selecting a voting group.....	55
Suspending a channel from a voting group.....	56
Hearing faint and noisy signals .....	57
Turning squelch override on and off.....	57
<b>5 Operating in P25 trunking mode .....</b>	<b>58</b>
About P25 trunking.....	59
Checking that the system is available .....	59
Making a talkgroup call.....	61
Receiving a talkgroup call .....	63
Making an individual call .....	63
Receiving an individual call .....	64
Emergency calls .....	64
Making a phone call .....	65
Unconnected calls .....	66
Failsoft mode operation.....	67
Radio-based failsoft .....	67
Infrastructure failsoft.....	67
Dynamic regrouping .....	68
<b>6 Scanning .....</b>	<b>69</b>
About scanning.....	70
Activating standard scanning .....	71
Activating background scanning.....	72
Changing the background scan group assigned to the function key .....	72
Activating in-zone scanning.....	73
Activating talkgroup scanning.....	74
Making a call while scanning.....	75
Suspending a channel from a scan group.....	75
Editing a scan group.....	76
Selecting a group to edit .....	76
Viewing group membership.....	78
Adding a channel to a group .....	78

Deleting a channel from a group .....	79
Changing a group's transmit channel .....	80
Changing a group's first or second priority channel ...	80
<b>7 P25 services .....</b>	<b>81</b>
Messages .....	82
Sending a message .....	82
Status update .....	84
Status request .....	85
Call alert .....	86
Radio check .....	87
Radio unit monitor .....	88
Radio inhibit and uninhibit .....	89
<b>8 Location services .....</b>	<b>91</b>
About location information .....	92
About location statuses .....	92
Viewing location information .....	93
Sending location information .....	94
Receiving and logging location information .....	96
Accessing logged location information .....	97
<b>9 Emergency operation .....</b>	<b>99</b>
About emergency calls .....	100
Making a priority call .....	101
Standard emergency mode .....	102
Stealth and non-stealth emergency modes .....	102
What happens during an emergency call? .....	103
Activating emergency mode .....	104
About manual emergency operation .....	105
Making a manual emergency call .....	105
Receiving a manual emergency call .....	106
Canceling a manual emergency call .....	106
Accessing emergency location information .....	108
Using the Location menu .....	108
Using the Last stored menu .....	109
Loneworker monitoring .....	109
Activating loneworker monitoring .....	110
Responding to a loneworker alarm .....	110
<b>10 Encryption .....</b>	<b>111</b>
About encryption .....	112
About the proper key detect feature .....	112
Encrypting calls .....	112
Making an encrypted call .....	113
Receiving an encrypted call .....	113

Changing the radio's encryption key .....	114
Changing the transmit encryption key .....	114
Changing the transmit encryption key back to the default setting .....	115
Changing the encryption keyset .....	115
Removing encryption keys from the radio .....	116
Deleting an encryption key .....	116
Deleting all encryption keys .....	116
Updating encryption keys over-the-air .....	117
<b>11 Customizing radio settings .....</b>	<b>118</b>
Reducing power consumption .....	119
Turning low power transmit on or off .....	119
Changing the volume of all audible indicators .....	120
Changing the volume of keypress tones .....	120
Changing to quiet operation .....	121
Changing to silent operation .....	121
Changing the external alert option .....	122
Turning on backlighting .....	122
Turning backlighting on momentarily .....	123
Adjusting the backlighting level .....	123
Adjusting the display contrast .....	124
<b>12 Troubleshooting .....</b>	<b>125</b>
When the radio won't turn on .....	126
Identifying the radio's audible tones .....	126
Viewing radio information .....	126
Changing the radio ID .....	127
Running diagnostics tests .....	127
Removing the microphone .....	129
General care .....	130
<b>13 Glossary .....</b>	<b>131</b>
<b>Simplified Declaration of Conformity .....</b>	<b>136</b>
<b>Tait Software Licence Agreement .....</b>	<b>137</b>

# Copyright and trademarks

All information contained in this document is the property of Tait International Limited. All rights reserved. This document may not, in whole or in part, be copied, photocopied, reproduced, translated, stored, or reduced to any electronic medium or machine-readable form, without prior written permission from Tait International Limited.

The word TAIT and the TAIT logo are trademarks of Tait International Limited.

All trade names referenced are the service mark, trademark or registered trademark of the respective manufacturers.

# Disclaimer

There are no warranties extended or granted by this document. Tait International Limited accepts no responsibility for damage arising from use of the information contained in the document or of the equipment and software it describes. It is the responsibility of the user to ensure that use of such information, equipment and software complies with the laws, rules and regulations of the applicable jurisdictions.

# Enquiries and comments

If you have any enquiries regarding this document, or any comments, suggestions and notifications of errors, please contact your regional Tait office.

# Updates of manual and equipment

In the interests of improving the performance, reliability or servicing of the equipment, Tait International Limited reserves the right to update the equipment or this document or both without prior notice.

# Intellectual property rights

This product may also be made under license under one or more of the following patents:

- US7203207, AU2004246135, CA2527142, GB2418107, HK1082608, MY134526, US8306071
- US7339917, AU2004246136, CA2526926, GB2418812, MY134217
- US7499441, AU2005262626, CA2570441, GB2430333, JP4690397, NZ551231, KR100869043, RU2351080, BRP10512052, MXPA06015241
- US 7200129, AU2005226531, CA2558551, CN1930809, GB2429378, JP4351720, BRP10508671, NZ549124,

## Environmental responsibilities

Tait International Limited is an environmentally responsible company which supports waste minimization, material recovery and restrictions in the use of hazardous materials. The European Union's Waste Electrical and Electronic Equipment (WEEE) Directive requires that this product be disposed of separately from the general waste stream when its service life is over. For more information about how to dispose of your unwanted Tait product, visit the Tait WEEE website at [www.taitradio.com/weee](http://www.taitradio.com/weee). Please be environmentally responsible and dispose through the original supplier, or contact Tait International Limited.

Tait International Limited also complies with the Restriction of the Use of Certain Hazardous Substances in Electrical and Electronic Equipment (RoHS) Directive in the European Union.

In China, we comply with the Measures for Administration of the Pollution Control of Electronic Information Products. We will comply with environmental requirements in other markets as they are introduced.



# For your safety

Before using your radio, please read the following important safety and compliance information.

## Radio frequency exposure information



For your own safety and to ensure you comply with the radio frequency (RF) exposure guidelines of the United States Federal Communication Commission's (FCC), Industry Canada, and those from other administrations, please read the following information before using this radio.

### Using this radio

You should use this radio only for work-related purposes (it is not authorized for any other use) and if you are fully aware of, and can exercise control over, your exposure to RF energy. To prevent exceeding FCC RF exposure limits, you must control the amount and duration of RF that you and other people are exposed to.

It is also important that you:

- Do not remove the RF Exposure label from the radio.
- Ensure this RF exposure information accompanies the radio when it is transferred to other users.
- Do not use the radio if you do not adhere to the guidelines on controlling your exposure to RF.

### Controlling your exposure to RF energy



**Warning** RF exposure hazard!

To comply with FCC and Industry Canada RF exposure limits, mount the antenna at a location such that no person or persons can come closer than 35 inches (0.9m) to the antenna:

For radios with a transmit power >25W:

VHF radios must be installed using an antenna mounted centrally on the vehicle roof, with a gain of 2.15dBi or 5.15dBi.

UHF and 800MHz radios must be installed using an

antenna mounted either centrally on the vehicle roof with a gain of 2.15dBi or 5.65dBi, or centrally mounted on the trunk with a gain of 5.65dBi.

900MHz radios must be installed using an antenna mounted either centrally on the vehicle roof or centrally mounted on the trunk with a gain of 2.15dBi or 8dBi.

For radios with a transmit power of 25W:

The radio must be installed using an externally mounted antenna with a gain of either 2.15dBi or 5.15dBi.

This radio emits radio frequency (RF) energy or radio waves primarily when calls are made. RF is a form of electromagnetic energy (as is sunlight), and there are recommended levels of maximum RF exposure.

To control your exposure to RF and comply with the maximum exposure limits for occupational/controlled environments, follow these guidelines:

- Do not talk (transmit) on the radio more than the rated transmit duty cycle. This is important because the radio radiates more energy when it is transmitting than when it is receiving.
- While you are transmitting (talking or sending data) on the radio, you must ensure that there is always a distance of 35 inches (0.9m) between people and the antenna. This is the minimum safe distance.
- Use the radio only with Tait-approved antennas and attachments, and make only authorized modifications to the antenna otherwise you could damage the radio and violate FCC regulations.

For more information on what RF energy is and how to control your exposure to it, visit the FCC website at [www.fcc.gov/oet/rfsafety/rf-faqs.html](http://www.fcc.gov/oet/rfsafety/rf-faqs.html).

## **Health Canada warning statement**

The installer of this radio equipment must ensure that the antenna is located or pointed such that it does not emit an RF field in excess of Health Canada limits for the general population; consult Safety Code 6, obtainable from the Health Canada's website

<http://www.hc-sc.gc.ca>.

## **Compliance with RF energy exposure standards**

This two-way radio complies with these RF energy exposure standards and guidelines:

- United States Federal Communications Commission, Code of Federal Regulations; 47 CFR §§ 1.1307, 1.1310, and 2.1091.
- American National Standards Institute (ANSI) / Institute of Electrical and Electronic Engineers (IEEE) C95.1-1992.
- Institute of Electrical and Electronic Engineers (IEEE) C95.1-1999 Edition.
- European Directive 2004/40/EC on minimum health and safety requirements regarding the exposure of workers to the risks arising from physical agents (electromagnetic fields).

This radio complies with the IEEE and ICNIRP exposure limits for occupational/controlled RF exposure environments at operating duty factors of up to 50% talk to 50% listen.

## **Conformité aux normes d'exposition à l'énergie RF**

Cette radio émetteur-récepteur se conforme aux normes et aux règlements d'exposition à l'énergie RF :

- La Commission fédérale de la communication des États-Unis, Code de règlements fédéraux (CFR) Titre 47 Sections 1.1307, 1.1310 et 2.1091 (radios mobiles) ou 2.1093 (radios portatives).
- American National Standards Institute (ANSI) / Institute of Electrical and Electronic Engineers (IEEE) C95.1-1992.

- Institute of Electrical and Electronic Engineers (IEEE) C95.1-1999 Edition.
- La directive européenne 2004/40/EC concernant les prescriptions minimales de sécurité et de santé relatives à l'exposition des travailleurs aux risques dus aux agents physiques (champs électromagnétiques).

Cette radio se conforme aux limites d'exposition de l'IEEE (FCC) et ICNIRP pour les environnements d'exposition au rayonnement RF professionnel et contrôlé aux cycles de marche de 50% en mode transmission et 50% en mode réception.

## **Radio frequency emissions limits in the USA**

Part 15 of the FCC Rules imposes RF emission limits on receivers. This radio complies with Part 15 of the FCC Rules. Operation is subject to the condition that this device does not cause harmful interference.

## **Radio frequency emissions limits in Canada**

This device complies with Industry Canada licence exempt RSS standard(s). Operation is subject to the following two conditions: (1) this device may not cause interference, and (2) this device must accept any interference, including interference that may cause undesired operation of the device.

Le présent appareil est conforme aux CNR d'Industrie Canada applicables aux appareils radio exempts de licence. L'exploitation est autorisée aux deux conditions suivantes : (1) l'appareil ne doit pas produire de brouillage, et (2) l'utilisateur de l'appareil doit accepter tout brouillage radioélectrique subi, même si le brouillage est susceptible d'en compromettre le fonctionnement.

## USA public safety bands (764–776MHz and 794–806MHz)

The Code of Federal Regulations (CFR) Title 47 Subpart R deals with the use of frequencies in the 764 to 776MHz and 794 to 806MHz bands.

### Low-power channels

This radio complies with §90.531 (b) (3) and §90.531 (b) (4) of 47 CFR. These sections state that only low-power transmission is permitted on the following channels:

- Regional Planning channels, as defined in §90.531 (b) (3).
- Itinerant channels, as defined in §90.531 (b) (4).

### Use of encryption

This radio complies with §90.553 (a) of 47 CFR. This states that:

- Encryption is not permitted on the nationwide Interoperability calling channels. These channels are defined in §90.531 (b) (1) (ii).
- Radios using encryption must have a readily accessible switch or control to allow the radio user to disable encryption.

## EMC regulatory compliance in Australia



This product meets all ACMA regulatory requirements for electromagnetic compatibility (EMC). For more information about EMC compliance, visit the ACMA website at [www.acma.gov.au](http://www.acma.gov.au).

## Frequency band reserved for distress beacons

Frequency band 406 to 406.1 MHz is reserved for use by distress beacons. Transmissions should not be made within this frequency band.

## Health, safety and electromagnetic compatibility in Europe

In the European Community, radio and telecommunications equipment is regulated by Directive 2014/53/EU. The requirements of this directive include protection of health and safety of users, as well as electromagnetic compatibility.

### Intended purpose of product

This product is an FM radio transceiver. It is intended for radiocommunication in the Private Mobile Radio (PMR) or Public Access Mobile Radio (PAMR) services, to be used in all member states of the European Union (EU) and states within the European Economic Area (EEA).

### Restrictions

This product can be programmed to transmit on frequencies that are not harmonized throughout the EU/EEA, and will require a licence to operate in each member state.

This product can be programmed for frequencies or emissions that may make its use illegal. Where applicable, a license must be obtained before this product is used. All license requirements must be observed. Limitations may apply to transmitter power, operating frequency, channel spacing, and emission.

### Declaration of conformity

Brief Declarations of Conformity appear on [page 136](#) of this booklet. To download the formal declaration of conformity, go to [www.taitradio.com/eudoc](http://www.taitradio.com/eudoc).

# Interference with electronic devices



**Warning** Some electronic devices may be prone to malfunction due to the lack of protection from RF energy that is present when your radio is transmitting.

Examples of electronic devices that may be affected by RF energy are:

- aircraft electronic systems
- vehicular electronic systems such as fuel injection, anti-skid brakes, and cruise control
- medical devices such as pacemakers and hearing aids
- medical equipment in hospitals or health care facilities.

Switch off the radio before boarding an aircraft. Using your radio while in the air is not permitted.

Consult the manufacturer (or its representative) of any such electronic devices to determine whether electronic circuits in those devices will perform normally when the radio is transmitting.



**Warning** If you have a pacemaker, immediately turn off the radio if you suspect it is interfering with the pacemaker.

If there is interference between your hearing aid and the radio, please discuss an alternative solution with the hearing aid manufacturer.

# Potentially explosive atmospheres and blasting areas



**Warning** Unless the radio is specifically certified for use in a potentially explosive atmosphere, turn off the radio before entering such an atmosphere. An explosion could cause serious injury or death. Examples of potentially explosive atmospheres include filling stations, and any environment where there are flammable liquids, gases, or dusts.



**Warning** Turn off the radio before approaching blasting caps, a blasting area, or any area where you are

instructed to turn off a two-way radio. Obey all signs and instructions. Interference with blasting operations could cause serious injury or death.

## Radio installation and operation in vehicles



**Warning** Keep the radio away from airbags and airbag deployment areas. Do not install, charge, or place a radio near such areas. An activated airbag can propel a portable radio with sufficient force to cause serious injury to vehicle occupants. An airbag may not perform to specification if obstructed by a radio.



**Warning** To avoid damage to existing wiring, airbags, fuel tanks, fuel and brake lines, or battery cables, refer to the installation guide for the radio, and to the vehicle manufacturer's manual, before installing electronic equipment in the vehicle.

Using a handheld microphone or a radio while driving a vehicle may violate the laws and legislation that apply in your country or state. Please check the vehicle regulations in your area.

## Radio protection when charging the vehicle battery

**Notice** Always remove the fuses from the radio power cable before charging the vehicle battery, connecting a second battery, or using power from another vehicle (e.g. when jump-starting the vehicle).

## Electromagnetic compatibility in European vehicles

In the European Community, radio equipment fitted to automotive vehicles is regulated by Directive 72/245/EEC and its amendments. The requirements of this directive cover the electromagnetic compatibility of electrical or electronic equipment fitted to automotive vehicles.



To meet the requirements of Directive 72/245/EEC and its amendments, installation of this product in a vehicle must be performed according to the instructions provided by the vehicle manufacturer.

**Notice** Failure to install the product correctly may void the vehicle's type-approval. The owner could be held responsible for any damage resulting from vehicle failure that can be attributed to RF energy interfering with the vehicle systems.

## Unapproved modifications or changes to radio

The radio is designed to satisfy the applicable compliance regulations. Do not make modifications or changes to the radio that are not expressly approved by Tait. Failure to do so could invalidate compliance requirements and void the user's authority to operate the radio.

## High radio surface temperatures



**Caution** The bottom surface of the radio and the heatsink fins can become hot during prolonged operation. Do not touch these parts of the radio.

### EN 62368 requirements (25 watt mobiles)

This radio complies with the European Union standard EN 62368 when operated up to the rated 33% duty cycle of two minutes transmit and four minutes receive, and with ambient temperatures of 30°C or lower.



**Caution** Operation outside these limits may cause the external temperature of the radio to rise higher than this standard permits.

# Menu maps

This section shows the menus and submenus that may be programmed for your radio. Some features are controlled by software licenses (SFEs) and may not be available with your radio.

## Main menu

### Channels

### Zones

### Local calls

### Set status

### Individual call

### Phone call

### Dial radio call

### Dial patch call

### Services

- Messages

- Status update

- Status request

- Call alert

- Radio check

- Radio monitor

- Radio inhibit

- Radio uninhibit

### Talkgroups

### Priority call

### Recent calls

### Security

- Encryption

- Change all

- Preset keys

- Change keyset

- OTAR

  - Rekey request

- Advanced

  - Zeroize key

  - Zeroize all

### Trunking

- Site lock

- Dynamic regrouping

- Band scan

- Repeater

  - Hunt force

  - Hunt toggle

  - Repeater toggle

### Emergency

- Acknowledge

- Last stored

### Radio settings

- See detailed menus on the following page.*

### Location Svcs

- Own Location

- Team locations

- Recent contacts

- Send logs

- Send on PTT

### Diagnostics

### Time and Date

- View clock

- Set time

- Time format

- Set date

## **Radio settings**

### **Functions**

- Low power tx
- Monitor
- Lock radio
- Set scan key
- Squelch override
- Scanning
- PA speaker
- Voice annunciation

### **Call Settings**

- Ignore 2-tone
- Call queuing

### **Extra features**

- Loneworker

### **Alert settings**

- Indicator level
- Keypress tones
- Quiet operation
- Silent operation
- External alert

### **Display settings**

- Backlighting
- Backlight level
- Contrast adjust
- Talk party ID
- RSSI

### **Radio info**

- Key settings
- Version info
  - Radio FW
  - Radio HW
  - Head FW
  - Head HW
- Radio ID
- Serial number
- Alias
- Customer info
- P25 IP address
- MDT IP address

### **Radio updates**

- Install update
- Undo previous

### **Advanced**

- Edit groups

# 1 About this guide

This user's guide provides information about TM9400 mobile radios.

The radio behavior described in this guide applies to radios with firmware version 2.11. To check the radio's firmware version, see "[Viewing radio information](#)" on page 126. If your radio does not operate as you expect, contact your radio provider for assistance.

## Safety warnings used in this guide

Please follow exactly any instruction that appears in the text as an 'alert'. An alert provides necessary safety information as well as instruction in the proper use of the product. This user's guide uses the following types of alert:



**Warning** This alert is used when there is a hazardous situation which, if not avoided, could result in death or serious injury.



**Caution** This alert is used when there is a hazardous situation which, if not avoided, could result in minor or moderate injury.

**Notice** This alert is used to highlight information that is required to ensure procedures are performed correctly. Incorrectly performed procedures could result in equipment damage or malfunction.



This icon is used to draw your attention to information that may improve your understanding of the equipment or procedure.

# Related documentation

The following documentation is also available for your Tait radio, which you can access from the Tait Technical Support website (<http://support.taitradio.com>):

- *Safety and Compliance Information*—supplied with each radio. (The same information is included in this user's guide.)
- *Installation Guide*—covers installing TM9400 mobile radios, microphones, antennas, emergency switches, and external alert devices.
- *Accessory installation instructions*—may be supplied with an accessory.

## 2 Getting started

This section gives an overview of your P25 radio, describes the radio's controls and indicators, and explains how the radio menus are organized.

### **This section covers:**

- [About P25 digital radios](#)
- [About the radio controls](#)
- [Understanding the radio display](#)
- [Understanding the radio indicators](#)
- [Using function keys to access frequently used features](#)
- [Navigating the radio's menus](#)

# About P25 digital radios

Your P25 digital radio can be programmed for P25 conventional or P25 trunked operation. Analog conventional operation is also available, with dual-mode channels able to transmit and receive both digital and analog calls.

You may notice differences between digital and analog calls in terms of:

- static noise in low signal areas, and
- radio coverage in marginal reception areas.

## Lack of static noise

On digital networks there is no static noise, even in low signal areas. This lack of static is because your digital radio removes the 'noise' from the call, so that you hear only clear voice.

## Coverage

With digital networks, a call remains clear and then drops off quickly at the border of a coverage area. The reason for this is that a digital call is either received or it isn't. With analog networks, the background noise in a call gets progressively worse when you are in fringe areas or even slightly outside normal coverage areas.

## P25 phase 2 operation

 This feature is controlled by a software license (SFE) and may not be available with your radio.

TM9400 radios can be programmed to operate on P25 trunked phase 2 networks. You will recognize that your radio operates on a P25 phase 2 network, if the RSSI indicator does not disappear while transmitting. This is because the radio continues to receive data in the background.

If one participant of a call uses a P25 phase 1 radio, the call may be made as a P25 phase 1 call.

# About the radio controls

The radio controls are the PTT key, volume control, on/off key, scroll keys, selection keys and function keys. Some keys have functions assigned to both short and long key presses:

- a short key press is less than one second, and
- a long key press is more than one second.

The radio controls and their functions are described in the following sections.

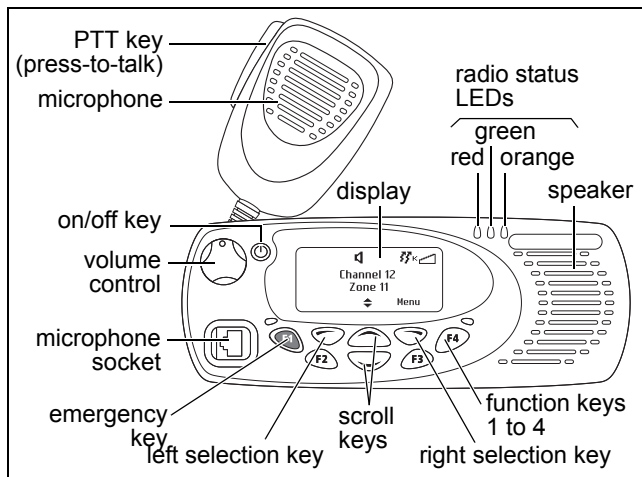

Name	Function
PTT key	Press and hold to transmit and release to listen
Volume control	Rotate to change the speaker volume
On/off key	Turn the radio on or off with a long press
Left and right selection keys	Action determined by the text above the selection key
Scroll keys	Scroll up and down through a list of menu options, scroll left and right in messages, or select the Quick Access menu
Emergency key	Activates emergency mode
Function keys	Programmed for frequently used options



# About the keypad microphone

Your radio may have a keypad microphone installed. The keypad microphone has a PTT key as well as alphanumeric keys, two scroll keys, and left and right selection keys.

The PTT key, the scroll keys and the selection keys all work in the same way as those on the radio control head (see ["About the radio controls"](#)).

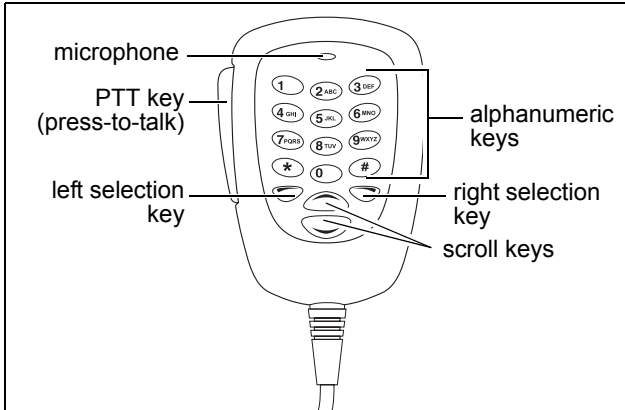

## About the hand-held control head

Your radio may have a hand-held control head installed, to enable you to operate the radio at a distance from the radio body.

The keys and controls work in the same way as those on the standard control head, with the exception of the PTT and volume up and down keys. The hand-held control head also has two additional function keys.

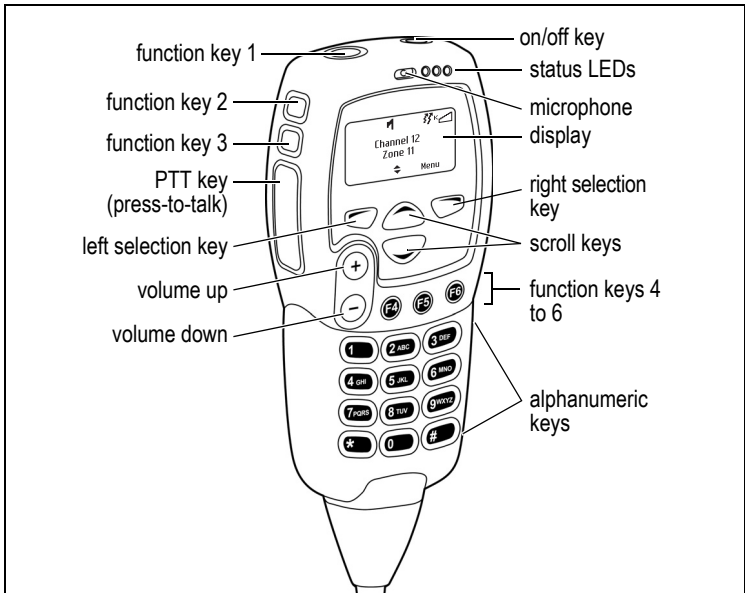















# Understanding the radio display

The messages and icons you see on your radio display depend on the mode in which your radio is operating and the way it is programmed.

## Radio display icons

These are some of the icons you may see on your radio display:

Icon	Meaning
	Signal strength indicator: the more bars, the stronger the signal being received by your radio
	Zone: this letter represents the zone in which your radio is operating, where <b>A</b> is zone 1, <b>Z</b> is zone 26 and <b>AD</b> is zone 30 (in the example shown, <b>K</b> represents zone 11)
	Trunking system available: your radio is operating on a P25 trunking system
	Transmit: your radio is transmitting
	Low-power transmit: your radio is set to transmit on low power
	Repeater talkaround: your radio is operating in repeater talkaround mode, or you are on a simplex channel
	Silent operation: your radio's audible tones have been turned off
	Encryption: your radio's transmissions are encrypted
	Scanning: your radio is monitoring a group of channels or talkgroups for activity
	Scanning: your radio is monitoring a group of channels or talkgroups for activity, and the currently selected channel or talkgroup is a member of the scan group.
	External alert: external alert is turned on
	Monitor or squelch override: monitor or squelch override is active
	Scrolling: you can use  or  to move through a list, or access a Quick Reference menu

# Understanding the radio indicators





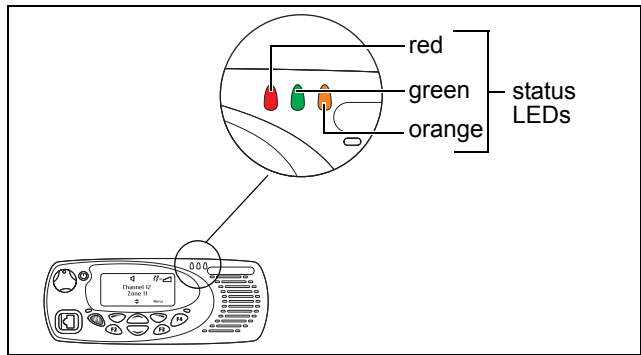

The status LED indicators and the radio's audible tones—together with the radio display—all combine to give you information about the state of your radio.

The most common way the indicators work is described in the following sections.

 The way these indicators behave may be affected by the way your radio is programmed.

## Status indicators



Color		Meaning
Red (transmit)		Glowing: your radio is transmitting
		Flashing: your transmit timer is about to expire
Green (receive)		Glowing: the current channel is busy
		Flashing: you have received a call or monitor is active
Orange (scanning)		Glowing: your radio is scanning a group of channels for activity
		Flashing: your radio has detected activity on a channel, and has halted on this channel

# Audible tones

The radio uses audible tones to alert you to its status:

- Radio controls and keypress tones—the tones and beeps you hear when you press your radio’s keys or use the controls.
- Incoming call tone—when the radio is receiving a call.
- Warning tones—when there is an error.



**Warning** If quiet or silent mode is turned on, you will not hear any alert tones.

Some of the more common audible tones are described below:

Tone	Meaning
One short beep	<ul style="list-style-type: none"><li>■ Valid keypress: The action you have attempted is permitted.</li><li>■ Function activated: A function has been turned on (using either the Main menu or a function key).</li></ul>
One short, low-pitched beep	Function deactivated: A function has been turned off (using either the Main menu or a function key).
One long, low-pitched beep	<ul style="list-style-type: none"><li>■ Invalid keypress: the action you have attempted is not permitted</li><li>■ Transmission inhibited: you have attempted to transmit, but for some reason you cannot make a call at this time.</li><li>■ Radio displays "key fail": the current channel is configured for encryption but the key is invalid. Transmission will be inhibited and received encryption calls cannot be heard. The radio needs to be re-keyed.</li></ul>

Tone	Meaning
Two short beeps	<ul style="list-style-type: none"> <li>■ Radio turned on: The radio is powered on and ready to use.</li> <li>■ Radio is revived: The radio has been made operable by your service provider.</li> </ul>
One short, high-pitched beep	Radio is stunned: The radio has been made inoperable by your service provider.
Two low-pitched beeps	Radio's temperature is high: The radio's temperature is in the high-temperature range, but the radio will continue to operate.
Two high-pitched beeps	Radio's temperature is very high: The radio's temperature is in the very high temperature range and all transmissions will now be at low power; if the radio's temperature rises outside this range, transmissions will be inhibited. Turn off the radio and allow it to cool down.
Continuous low-pitched tone	Radio system error: A system error has occurred and the radio may be inoperable. Contact your radio provider.
Two long high-low pitched tone pairs	Synthesizer is out-of-lock: The radio's synthesizer is out-of-lock on the current channel and you cannot operate on that channel ( <b>Out of Lock</b> appears on the display).

## Voice annunciation

Your radio may be programmed to play a pre-recorded message for the start-up channel, when changing a channel, or when loneworker monitoring has been turned on or off.

# Using function keys to access frequently used features

The function keys provide access to some of the features you use most often. These features are assigned to the function keys when the radio is programmed. Some keys may have a feature associated with both a short key press and a long key press.

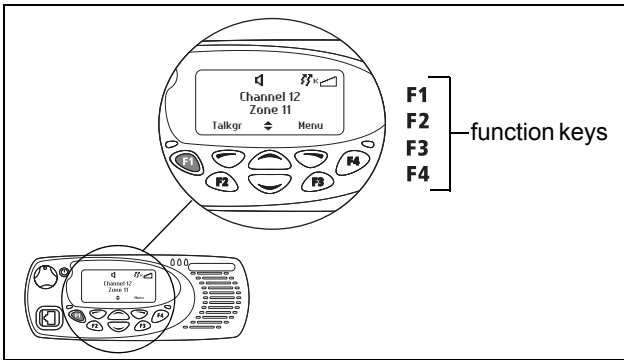

## Viewing the function key settings

Use the Main menu to check the features assigned to your radio's function keys:

- 1 Press **Menu** and select **Radio settings > Radio info > Key settings**.
- 2 In the Key Settings menu, scroll through the list of function keys.
- 3 Press **Select** to view details of the function associated with a particular function key.

The example shown is for a function key programmed to turn backlighting on and off.



- 4 Press **Back** to return to the Key Settings menu.

Use the following table to record the function keys programmed for your radio:

	Short key press	Long key press
F1		
F2		
F3		
F4		

For more information about the function keys that can be programmed on your radio, contact your radio provider.

## Navigating the radio's menus

Your radio has a number of menus, each containing lists or submenus. The menus available depend on the way your radio is programmed.

### Using the Main menu

To access the Main menu, press the right selection key whenever **Menu** appears above it.

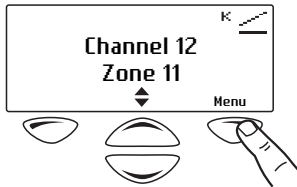

Use the scroll keys to move through the menu list.

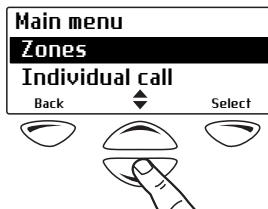

When the menu you want is highlighted, press **Select** to open the menu you have chosen.



-  To quickly exit the menu system, press and hold the left selection key when the word **Cancel** or **Back** appears above it.

## Accessing frequently used menus

Depending on how your radio is programmed, you may have two different Quick Access menus. One Quick Access menu is displayed when you press a scroll key, and the other when you press the left selection key. These give you easy access to the menus you use most often.

### Using the scroll key Quick Access menu

There are two ways to use this Quick Access menu:

- Use the scroll keys to scroll through a list of zones or channels.
- Press the scroll keys and the Quick Access menu appears.

In this example, the **Channels** menu is the Quick Access menu. Use the scroll keys to go directly to the **Channels** menu.

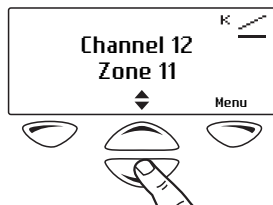

The **Channels** menu, with a list of your available channels, is now displayed.

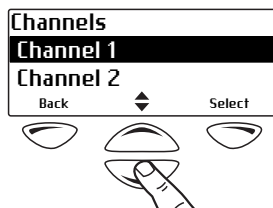

## Using the left selection key Quick Access menu

The text above the left selection key corresponds to the Quick Access menu, for example, **Zones**.

To use this Quick Access menu:

- Press the left selection key and the associated menu appears.

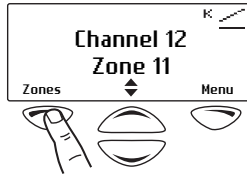

# 3 Basic operation

This section describes the basic operation of your radio.

**This section covers:**

- Turning the radio on and off
- Adjusting the speaker volume
- Activating the external speaker
- Locking and unlocking the keypad
- Selecting a zone
- Selecting a channel
- Limiting call time
- Checking recent calls
- Setting and viewing the radio's time and date
- Updating the radio over the air

# Turning the radio on and off

Long press the on/off key to turn the radio either on or off.

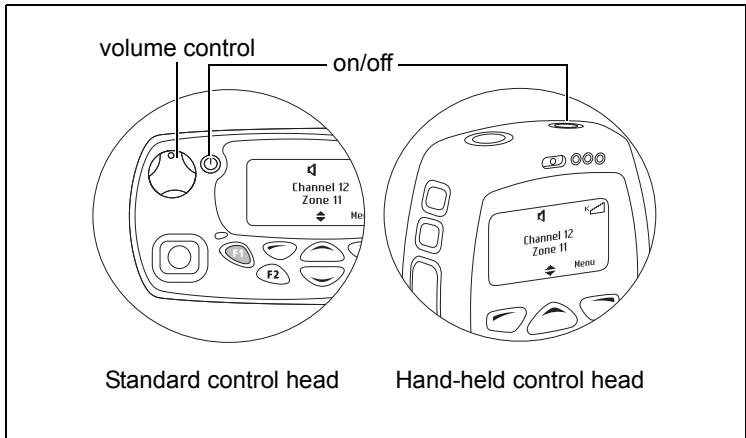

When the radio is first turned on, the red, green, and orange LEDs flash briefly, and the radio gives two short beeps. A brief message may appear on the display.

## Security lock on power-up feature

Your radio may be automatically locked each time it is powered-up. If the message **Enter PIN** appears in the display, enter your assigned PIN (personal identification number). See [“Unlocking the radio”](#) below.

### Locking the radio

- 1 Press **Menu** and select **Radio settings > Functions > Lock radio**. (Depending on how your radio is programmed, you may be able to press a function key to turn radio lock on and off.)
- 2 Scroll to either **On** or **Off** and press **Select**. (The current setting is highlighted.)

The radio is now locked, and the message **Enter PIN** appears in the display.

The radio remains locked until the correct sequence of keys is pressed. If you forget the unlock sequence or you do not know it, contact your radio provider for assistance.

### Unlocking the radio

- To unlock your radio, use the unlock sequence you have been given. (This is a pre-programmed sequence of four keys.)

## Adjusting the speaker volume

### Standard control head

Rotate the volume control clockwise to increase the speaker volume and counterclockwise to decrease the volume. The raised dot indicates the current volume setting.

### Hand-held control head

Press ⊕ to increase the speaker volume, and ⊖ to decrease the volume.

- ⓘ The volume control also changes the volume level of the radio's audible indicators.

## Activating the external speaker

An external speaker is used to increase the volume of the audio from the radio's standard speaker.

To check the current state of the external speaker:

- Short press the function key programmed for external speaker.

The message **PA Speaker is active** (or **PA Speaker is not active**) briefly appears in the display.

To turn on the external speaker:

- Long press the function key programmed for external speaker.

The message **PA Speaker Activated** briefly appears in the display.

Adjust the volume using either the volume control (standard control head), or the ⊕ and ⊖ keys (hand-held control head).

To turn off the external speaker:

- Long press the function key programmed for external speaker.

The message **PA Speaker Deactivated** briefly appears in the display.

## Locking and unlocking the keypad

The keypad lock feature prevents you from pressing a key accidentally. The number of keys that are locked depends on the way your radio is programmed.

If you receive a call while the keypad is locked, press any key to answer.

To lock the keypad:

- Press and hold the right selection key for about one second.

(Depending on your radio model and the way it is programmed, you may be able to use the left selection key to lock the keypad.)

The message **Keypad locked** briefly appears in the display, and **Unlock** appears above the right selection key, in place of **Menu**.

When any of the locked keys are pressed, the message **Keypad lock active** appears.

To unlock the keypad:

- Depending on the programming, press and hold the right or left selection key for about one second.

# Selecting a zone

Your radio may be programmed to use zones. A zone is a collection of channels. Zones are a way of grouping channels, for example, by public safety agency type (fire, police, ambulance, etc.) or by geographical region (Dallas, Houston, etc.).

To select a zone:

- 1 Press **Menu** and select **Zones**.
- 2 Scroll to the zone you want.
- 3 Press **Select**.

Your radio may indicate the zone in which it is currently operating in the following ways:

- the name of the zone appears below the channel name in the default radio display, or
- the zone icon appears as a letter in the top right corner of the display.

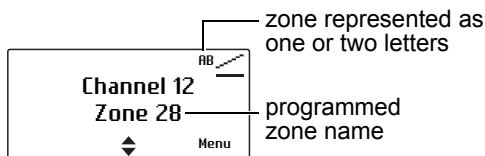

## Other ways of selecting a zone

You may also be able to use the following controls to select a zone:

- left selection key (see ["Using the left selection key Quick Access menu" on page 34](#))
- scroll keys (see ["Using the scroll key Quick Access menu" on page 33](#))
- function keys to scroll through zones

# Selecting a channel

## Using the Main menu

- 1 Press **Menu** and select **Channels**.

- 2 Scroll to the channel you want and press **Select**.

### Using the keypad

- 1 Dial the number associated with the channel using the alphanumeric keypad.

To delete a digit that you have dialed incorrectly, press **Clear**.

- 2 Press **Select** or **#** to confirm the channel change.

The channel name associated with the new channel now appears in the default display.

### Other ways of selecting a channel

You may also be able to use the following controls to select a channel:

- function key (see ["Accessing frequently used menus" on page 33](#))
- left selection key (see ["Using the left selection key Quick Access menu" on page 34](#))
- scroll keys (see ["Using the scroll key Quick Access menu" on page 33](#))

## Limiting call time

Your radio may limit the amount of time you can talk (transmit) continuously. This is known as the 'transmit timer' or 'time-out timer' and allows other radio users to make calls on that channel.

The radio warns you before the transmit timer expires by beeping three times. The red status LED flashes and the message **Transmit timeout imminent** appears in the display.



# Checking recent calls

This feature is available for digital channels only and applies to individual calls and call alert pages only.

Your radio may be able to store a list of the last 20 calls. These calls may be calls that you have received, calls that you have made, or calls that you have missed.

To use your recent calls list to make a call:

- 1 Press **Menu** and select **Recent calls**. (Depending on how your radio is programmed, you may be able to press a function key or use your Quick Access menu to select recent calls.)

The most recent call is displayed at the top of the list. If you have not participated in any calls since your radio was switched on, the message **No items in list** appears in the display.

- 2 Scroll through the list of recent calls until the call you want appears, and then press **Call**.

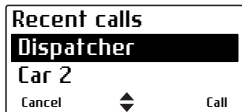

The message **Call...?** briefly appears in the screen.

Press the PTT key to make the call.

- 3 Alternatively, scroll through the list of recent calls until the call you want appears, and press the PTT to make the call immediately.

# Setting and viewing the radio's time and date

Your radio may be programmed to use its internal real-time clock. You may be able to view the time and date via a function key or via the radio menu. Other features such as the call queue may also make use of the feature by showing entries based on the current clock setting.

To set the time, date, and time format:

 Your radio may be programmed to allow you to set time and date manually, or time and date can be updated automatically using a GPS source.

- 1 Press **Menu** and select **Time and Date** and the corresponding option.
- 2 Follow the prompts on the display.

To view the time and date:

- Press **Menu** and select **Time and Date** > **View clock** (Depending on how your radio is programmed, you may be able to press a function key to view the time and date).

## Updating the radio over the air

Configuration updates that are delivered over the air are either installed immediately, or once the user has accepted the activation prompt. If the activation prompt is declined, you can manually install the configuration update.

- 1 Press **Menu** and select **Radio updates** > **Install update**.
- 2 Follow the prompts on the display.

You can also revert to the previous configuration:

- 1 Press **Menu** and select **Radio updates** > **Undo previous**.
- 2 Follow the prompts on the display.

# 4 Operating in conventional mode

This section explains how to operate your radio in conventional mode. This includes how to make and receive calls, and use your radio in different repeater areas.

## **This section covers:**

- [Making a call](#)
- [Making an individual call](#)
- [Understanding talkgroups](#)
- [Making a local call](#)
- [Connecting to a telephone network](#)
- [Making an emergency call](#)
- [Sending a status message](#)
- [Receiving calls](#)
- [Communicating directly with other radios](#)
- [Checking that the channel is clear](#)
- [Using the radio in different repeater areas](#)
- [Hearing faint and noisy signals](#)

# Making a call

To make a call:

- 1 Select the required zone (see ["Selecting a zone" on page 39](#)).
- 2 Select the required channel (see ["Selecting a channel" on page 39](#)).
- 3 Lift the microphone off the microphone clip.
- 4 Hold the microphone about 2 inches (5 cm) from your mouth and press the PTT key to transmit.

If the channel is busy, you may not be able to transmit. Wait until the green status LED has stopped glowing, and then try again.

- 5 Speak clearly into the microphone and release the PTT key when you have finished talking.

While you are transmitting the red LED glows and  appears on the display.

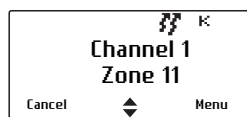

- 6 Finish your conversation as soon as possible and release the PTT key. For a short time, your radio may prevent you from making another call.

# Making an individual call

This feature is available for digital channels only. For analog individual calls, see ["Making a local call" on page 47](#).

To make a call to one person rather than a group of people:

- 1 Press **Menu** and select **Individual call**. (The person to whom you last made an individual call is highlighted.)

(Depending on how your radio is programmed, you may be able to press a function key or use your Quick Access menu to select individual calls.)

- 2 Scroll to the person you want to call and press the PTT key to make the call immediately.
- 3 Alternatively, scroll to the person you want to call and press **Select**.

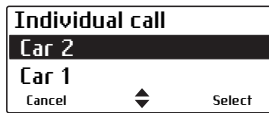

The message **Call...?** briefly appears on the display.

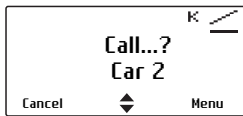

- 4 Press the PTT key to make the call.

## Understanding talkgroups

This feature is available for digital channels only.

A talkgroup is a collection of radio users with whom you want to have private conversations. For example, a state's public safety agencies could have the following talkgroups:

- Local talkgroups—used by a specific agency to communicate within their own local agency. It may even be made up of a county of public safety officers.
- Regional talkgroups—used by large state agencies that have regional divisions.
- Statewide talkgroups—used by an agency to communicate with public safety members in another region. Statewide talkgroups, as their name suggests, enable public safety agencies to communicate with each other from one end of the state to the other.

- Special event talkgroups—may be used to manage emergencies encompassing a large area, or even events such as visits by heads of state.

## Making a talkgroup call

To make a call to the currently selected talkgroup

- Press the PTT key.

## Changing a talkgroup

- 1 Press **Menu** and select **Talkgroups**.

(Depending on how your radio is programmed, you may be able to use a Quick Access menu to go to the Talkgroup menu.)

- 2 Scroll through the list of talkgroups to the one you want and press **Select**.

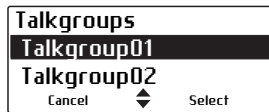

- 3 Press the PTT key to make a call to the currently selected talkgroup.

# Making a local call

For analog channels, each channel on your radio may have one or more local calls programmed. For digital radio-to-radio calls, see "[Making an individual call](#)" on [page 44](#).

## Using the Main menu

- 1 Select the required channel.
- 2 Press **Menu** and select **Local calls**.



- 3 In the **Local calls** menu, scroll through the list of local calls until the call you want appears.
- 4 Press **Send**.

The call details appear on the display, the red LED glows, and  appears on the display.

## Using the Quick Access menu

- 1 Select the required channel.
- 2 Press one of the scroll keys or the left selection key to open the **Local calls** menu.
- 3 Scroll through the list of local calls until the call you want appears.
- 4 Press **Send**.

The call details appear on the display, the red LED glows, and  appears on the display.

## Dialing a local call



This feature is only available for radios with alphanumeric keys.

To make a local call to another radio or group of radios:

- 1 Select the required channel.

**2** Press **Menu** and select **Dial radio call**.

Alternatively, your radio may be programmed so a local call can be dialed directly from the default display. In this case, you can start dialing the call without selecting the menu option.

A series of **X** and **S** characters may appear, prompting you to dial over them.

**3** Dial the number using the alphanumeric keys.



Your radio may be programmed so you can dial group tones using the \* and # keys. Dial \* to fill one **X**. Dial # to fill the current **X** and all subsequent **X** characters in the current burst.

**4** Press **Send** (if the Send option appears).

The call details appear on the display, the red LED glows, and **↔** appears on the display.

When the called party receives your call, the message **Ack received** may appear on the display.

## Connecting to a telephone network

For analog channels, you may be able to use your radio to connect to a telephone network. This type of call is known as a DTMF patch call.

To make a DTMF patch call, you may be able to either:

- use a programmed function key
- use the Main menu to dial the call
- make a local call (see ["Making a local call" on page 47](#)),



## Using a function key

 Depending on how DTMF patch calls are programmed, some or the following steps may not be necessary.

- 1 Select the required channel.
- 2 Press the function key programmed for DTMF patch call.  
Your radio may send tones to capture the line.
- 3 Press **Send**, or press the function key a second time, to send the preset number.  
You may hear telephone dialing and ringing tones.
- 4 Proceed with your call.
- 5 Press **End**, or give a long press on the function key, to end the call.  
Your radio may send tones to release the line.

## Using the Main menu

 This feature is only available for radios with alphanumeric keys.

To dial a DTMF patch call by using the Main menu:

 Depending on how DTMF patch calls are programmed, some or the following steps may not be necessary.

- 1 Select the required channel.
- 2 Press **Menu** and select **Dial patch call**.
- 3 Dial the required number using the alphanumeric keys.
- 4 Press **Send**.  
Your radio may send tones to capture the line.
- 5 Press **Send** to send the number dialed in step 3.  
You may hear telephone dialing and ringing tones.
- 6 Proceed with your call.

- 7 Once the call has finished, press **End**.

Your radio may send tones to release the line.

## Making an emergency call

For information about making and ending emergency calls together with a explanation of how your radio behaves in emergency mode, see ["About emergency calls" on page 100](#) and ["Standard emergency mode" on page 102](#).

## Sending a status message

For analog channels, your radio may be able to maintain a record of your current status. This status may be sent with outgoing calls programmed to contain status information. If the radio receiving your message has been programmed with the same status messages, it will decode and display your message. The message indicates your current activity or location, such as "en route" or "at lunch".

To change you current status:

- 1 Press **Menu** and select **Set status**.



- 2 In the **Set status** menu, scroll through the list of status messages until the message you want appears.
- 3 Press **Select**. The message **Status updated** appears on the display.

# Receiving calls

When a call is received with valid signaling, the radio unmutes and you can hear the call.

## Identifying the talking party or caller

Your radio may be programmed to display the name or radio ID of the talking party or caller.

For digital calls, if the name of the talking party is in the call list, the radio will display the name of the talking party.

If this name is not in the call list, only the radio ID is shown.

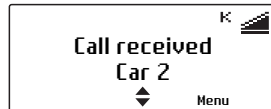

Digital talkgroup calls will first display the name of the talkgroup. While a party is talking, the radio will also display the name or radio ID of the talking party.



Analog calls may be programmed to broadcast the caller's radio ID with the call.

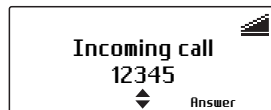

## Turning digital caller ID on and off

Your radio may be programmed to allow you to turn the talking party ID for digital calls on and off.

- 1 Press **Menu** and select **Radio settings > Display settings > Talk party ID**.
- 2 Scroll to either **On** (or **Off**) and press **Select**. (The current setting is highlighted.)

The message **Talking party ID activated** (or **deactivated**) appears in the display.

## Receiving a two-tone call

This feature is available for analog channels only.

Two-tone signaling is used to call either individual or groups of radios. When your radio receives a two-tone call that it can decode, it beeps, indicating which type of two-tone call has been received.

- One long beep: a two-tone individual call has been received.
- Two medium beeps: a two-tone group call has been received.
- Three short beeps: a two-tone super group call has been received. A super-group call is addressed to all radios in the fleet.

Press the PTT key and begin speaking.

### Overriding two-tone signaling

You can override two-tone signaling using a function key, if your radio is programmed in this way.

- Press the function key to override two-tone signaling on a channel, and hear all two-tone calls.

The message **Ignore two-tone activated** (or **deactivated**) appears on the display.

# Communicating directly with other radios

You can bypass the radio repeater and communicate directly with another radio using the radio talkaround feature. You can do this when you are out of range of the repeater, or if the repeater is busy.

While repeater talkaround is active, all calls are made on your current channel's receive frequency.

## Turning repeater talkaround on and off

You can turn repeater talkaround on and off using a function key, if your radio is programmed in this way.

- Press the function key to turn repeater talkaround on.

The message **Talkaround activated** (or **deactivated**) appears and  appears in the display.

Repeater talkaround remains on until you press the function key again.

# Checking that the channel is clear

Monitor allows you to override some or all of the radio's mutes, allowing you to hear if there is any traffic (including talkgroup and individual calls) on a channel.

For analog channels, this is so that you can check that the channel is clear before you make a call.

## Turning monitor on and off

### Using the microphone hookswitch

Your radio may be programmed to turn monitor on whenever the microphone is removed from the microphone clip. Monitor is turned off when the microphone is replaced.

### Using the Main menu

- 1 Press **Menu** and select **Radio settings > Functions > Monitor**.

(Depending on how your radio is programmed, you may be able to press a function key to toggle monitor on and off.)

- 2 Scroll to **On** (or **Off**) and press **Select**.

While monitor is active,  appears in the display.

# Using the radio in different repeater areas

Your radio may have a group of channels programmed as a voting group. The channels in the voting group all carry the same traffic, but from different repeaters. As your radio moves in and out of different repeater coverage areas, the best communication channel is automatically selected for you to use.

This channel is known as the 'home' channel, and may be the channel you make and receive calls on.

While voting is active, the orange LED glows and  appears in the display.

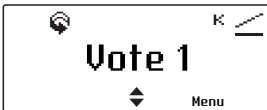

## Selecting a voting group

### Using a function key

To use a function key to select a voting group:

- Press the function key to select and activate a preset voting or scan group.

### Using the Main menu

To select a voting group using the Main menu:

- 1 Press **Menu** and select **Channels**.
- 2 Scroll to the group you want and press **Select**.

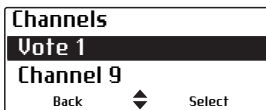

## Suspending a channel from a voting group

You may be able to use the function key programmed for 'nuisance delete' to temporarily remove one of the channels from the voting group.

To remove a channel from a voting group:

- 1 Wait until the radio has stopped on the channel that you want to remove from the voting group.
- 2 Press the function key programmed for nuisance delete.

If the channel has been removed successfully, the message **Channel nuisance deleted** briefly appears on the display.

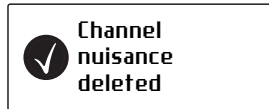

The channel remains removed from the voting group until you either select another voting group or the radio is turned off and then on again.

The function key programmed to activate a voting group may be programmed so that a short key press activates voting and a long key press activates nuisance delete.



# Hearing faint and noisy signals

This feature is only applicable to analog channels.

Usually the radio's squelch mute (known as 'squelch') prevents you from hearing faint or noisy calls on a channel. Without squelch, the radio's speaker would 'chatter' in low signal strength areas.

On occasions when you want to hear everything that is being said on a channel, even if it is hard to understand, you can use the squelch override feature to force the mute open.

## Turning squelch override on and off

- 1 Press **Menu** and select **Radio settings > Functions > Squelch override**.

(Depending on how your radio is programmed, you may be able to press a function key to turn squelch override on and off.)

- 2 Scroll to **On** (or **Off**) and press **Select**.

The message **Squelch override activated** (or **deactivated**) appears in the display.

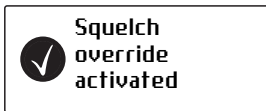

# 5 Operating in P25 trunking mode

This section explains how your radio operates on a P25 trunking system. This includes how to make group calls, individual calls and phone calls.



This feature is controlled by a software license (SFE) and may not be available with your radio.

The features described in this chapter are only available for radios configured for P25 trunking operation.

## **This section covers:**

- [About P25 trunking](#)
- [Checking that the system is available](#)
- [Making a talkgroup call](#)
- [Receiving a talkgroup call](#)
- [Making an individual call](#)
- [Receiving an individual call](#)
- [Emergency calls](#)
- [Making a phone call](#)
- [Unconnected calls](#)
- [Failsoft mode operation](#)
- [Dynamic regrouping](#)

# About P25 trunking

Your radio may be able to operate on a P25 trunking system as well as a conventional repeater-based system. On a conventional system, radio users compete for access to individual channels, and one channel can be overloaded with traffic while others are often unused.

The trunking system allows several channels to be automatically shared by a number of radio users. These traffic channels are pooled and allocated, as required, for the duration of a call. As calls are completed, the traffic channels are returned to the pool, to be used for other calls. This system means reduced waiting times to make calls.

## Checking that the system is available

When you first switch to a talkgroup configured for P25 trunking, the radio attempts to access the network and register on a control channel.

If registration is successful, the trunking system available icon  appears in the display.

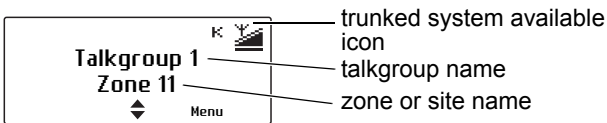

### Registration is unsuccessful

If registration is not successful,  does not appear, and the display shows **No service**.



The radio may sound five beeps, followed by a repeating double beep. The double beep continues until registration is successful.

## Service is lost

If access to the trunking system is lost, 'K' no longer appears, the bars in the RSSI icon disappear , and the display shows **No service**.



The radio sounds five beeps to indicate the loss of service, followed by a repeating double beep. The double beep continues until service is restored.

## Site trunking operation

During normal trunking operation, your radio may roam between a number of sites. This behavior is transparent to you, unless there is a problem with a system controller. When this happens, the radio enters 'site trunking' mode, and you will only be able to communicate with users within a single site.

While in site trunking mode, the display shows **Site Trunking**, and the radio sounds a repeating double beep. The double beep continues until normal service is restored.

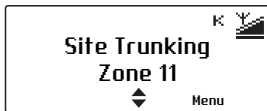

When access to the zone controller is available again, your radio automatically returns to normal multi-site operation.

## P25 phase 1 features not supported in P25 phase 2

If the user tries to use a P25 phase 1 feature which is not yet supported in P25 phase 2, the radio may show a system error.

## P25 phase 2 fallback mode

If there is a fault on the phase 2 network, operation may fall back to phase 1 mode.

## Failsoft operation

Your radio may be programmed to enter 'failsoft' mode when service is lost due to failure of a trunking site controller. For information about failsoft mode, see "[Failsoft mode operation](#)" on page 67.

# Making a talkgroup call

A talkgroup is a collection of radios on a trunking system. Trunked talkgroups are found in the Channels menu, along with conventional channels that may also be available for the currently selected zone.

Depending on how your radio is programmed, you may be able to press a function key or use your Quick Access menu to select a trunked talkgroup.



**Caution** In some situations, your call will not proceed. For an explanation of the radio behavior, see "[Unconnected calls](#)" on page 66.

To make a talkgroup call on a trunking system:

- 1 Select the required zone:
  - Press **Menu** and select **Zones**.
  - Scroll to the zone you want, and press **Select**.

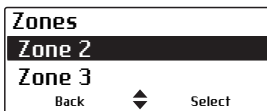

(Depending on how your radio is programmed, you may be able to press a function key or use your Quick Access menu to select a zone.)

Your radio now indicates the zone in which it is operating, either as a letter in the top right corner of the display, or as a zone name in the second line of the display.

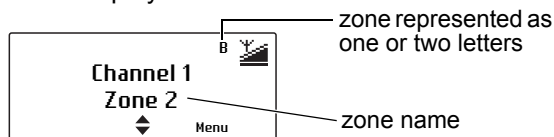

**2** Select the required talkgroup:

- Press **Menu** and select **Channels**.
- Scroll to the talkgroup you want, and press **Select**.

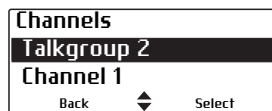

(Depending on how your radio is programmed, you may be able to press a function key or use your Quick Access menu to select a talkgroup.)

Your radio now indicates the currently selected talkgroup.

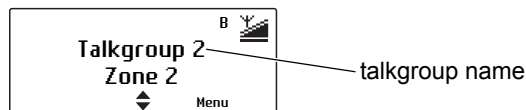

- 3** To call this talkgroup, hold the microphone about 2 inches (5 cm) from your mouth.
- 4** Press and hold the PTT key to transmit.
- 5** When you hear three short beeps, speak clearly into the microphone and release the PTT key when you have finished talking.

While you are transmitting, the red LED glows and  appears in the display.

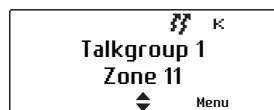

# Receiving a talkgroup call

To hear calls from other members of a talkgroup, your radio must have that talkgroup selected, or the talkgroup must be part of an active scan group.

For information about selecting a talkgroup, see ["Making a talkgroup call" on page 61](#), and for information about talkgroup scanning, see ["Activating talkgroup scanning" on page 74](#).

When you receive a call from a talkgroup, the radio displays the name or the identity of the talkgroup, and that of the calling radio.

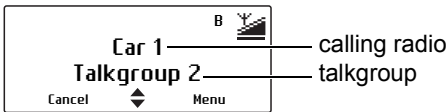

# Making an individual call



**Caution** In some situations, your call will not proceed. For an explanation of the radio behavior, see ["Unconnected calls" on page 66](#).

To make a call to one radio on a trunking system:

- 1 Press **Menu** and select **Individual call**.  
(The person to whom you last made an individual call is highlighted.)

Depending on your radio model and how it is programmed, you may be able to dial the identity of the radio you want to call, press a function key or use your Quick Access menu to select an individual call.

- 2 Scroll to the person you want to call and press **Select** or press the PTT key.

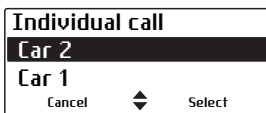

The message **Calling...** briefly appears.

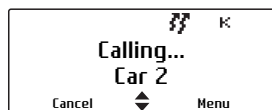

- 3 When the called party accepts the call, you will hear three short beeps.
- 4 Once the called party has finished talking, press and hold the PTT key to transmit, speak clearly into the microphone, and release the PTT key when you have finished talking.

## Receiving an individual call

When you receive a call from an individual radio, your radio displays the caller's name or identity.

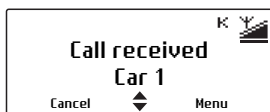

The radio rings and the green LED flashes until the call is answered.

Press the PTT key to accept the call, or **Cancel** to reject the call.

## Emergency calls

In an emergency, you can summon help by sending an emergency call. When an emergency call is initiated, the radio enters 'emergency mode'. For more information on emergency mode, see "[Standard emergency mode](#)" on page 102.

### Making an emergency call

You can make an emergency call using the emergency function key or a hidden switch.

- Press the function key or hidden switch to activate emergency mode.



The message **Emergency mode** appears and the radio sounds three short beeps, rising in pitch (non-stealth emergency only).

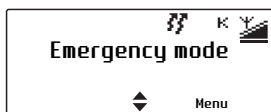

## Receiving an emergency call

When you receive an emergency call, your radio displays the caller's name or identity and sounds a long beep.

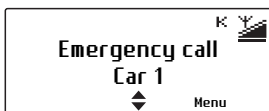

## Making a phone call

This feature is only available for radios with alphanumeric keys.

You may be able to use your radio to connect to a telephone network and make a phone call.



**Caution** In some situations, your call will not proceed. For an explanation of the radio behavior, see "[Unconnected calls](#)" on page 66.

To make a phone call on a trunking system:

- 1 Press **Menu** and select **Phone call**. (The phone call you last dialed appears in the display.)  
(Depending on how your radio is programmed, you may be able to press a function key or use your Quick Access menu to open the Phone Call menu.)
- 2 Scroll to the number or person you want to call, or dial the required number using the alphanumeric keys.

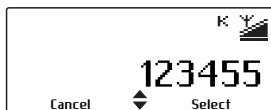

3 Press **Select** or the PTT key.



Call progress will be indicated by “ring” or “busy” tones as for a standard telephone call.

4 When the call is answered, proceed with your conversation.

5 At the completion of the call, or if the dialed number is busy or does not answer, press the **End** left selection key.

## Unconnected calls

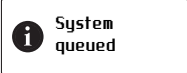
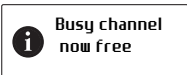
If your call is not connected, the way your radio behaves is explained in the following table.

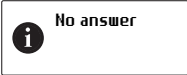
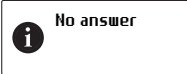
Radio behavior	Explanation
 <p>The display shows an information icon (i) and the text "System queued".</p>	The system is too busy to process your talkgroup or individual call.
 <p>The display shows an information icon (i) and the text "Busy channel now free".</p>	The system is now available to process your talkgroup or individual call.
<p>The radio sounds three short beeps.</p>	
 <p>The display shows "Talkgroup 1", "No service", a signal strength indicator, and a "Menu" button.</p>	You have selected a talkgroup that does not currently exist on the system. Your display shows that you have lost service and  no longer appears. See " <a href="#">Service is lost</a> " on page 60.
<p>The radio sounds five beeps, followed by a repeating double beep.</p>	
 <p>The display shows an information icon (i) and the text "No answer".</p>	You have attempted to make an individual call to a radio that does not currently exist on the system.
<p>The radio sounds two short beeps.</p>	You have attempted to make an individual or phone call, but you are not authorized to do this.
 <p>The display shows an information icon (i) and the text "No answer".</p>	Your individual or phone call has been rejected or is unanswered.
<p>The radio sounds two short beeps.</p>	

# Failsoft mode operation

If your radio is unable to access the trunking system, it may be programmed to enter failsoft mode. Failsoft mode operates in one of two ways: 'radio-based' failsoft and 'infrastructure' failsoft.

## Radio-based failsoft

When you lose access to the trunking system, 'K' no longer appears, the bars in the RSSI icon disappear , and the display shows **No service**.



After a short time, your radio switches to a programmed conventional communications channel.

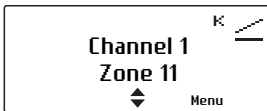

The radio remains on that channel until you select a trunked talkgroup with access to the trunking system.

## Infrastructure failsoft

Your radio receives a message from the trunking infrastructure to say that the trunking system is now operating in failsoft mode.

While in failsoft mode, the display shows **Failsoft**, and the radio sounds a repeating double beep. The double beep continues until normal service is restored.

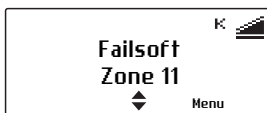

You may still be able to communicate with your dispatcher and other talkgroup members, depending on the type of system failure that has occurred, and how your radio is programmed.

When the trunking system returns to normal operation, your radio is notified, and will attempt to register on the control channel it was previously using.

## Dynamic regrouping

The dynamic regrouping feature allows you to send a dynamic regrouping request to your dispatcher. Your dispatcher can then reassign your radio to a special communications group.



**Caution** While you are operating on this group, normal channel selection may be disabled.

To send a dynamic regrouping request:

- Press **Menu** and select **Trunking > Dyn Regrouping**.

When you press **Select**, a message appears in the display.

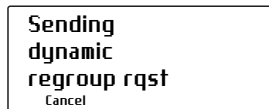

If the request is successful, an acknowledgement message is displayed.

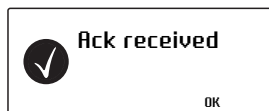

# 6 Scanning

This section explains the different types of scanning that may be available on your radio, and also how to view and edit scan group members.

## **This section covers:**

- [About scanning](#)
- [Activating standard scanning](#)
- [Activating background scanning](#)
- [Activating in-zone scanning](#)
- [Activating talkgroup scanning](#)
- [Making a call while scanning](#)
- [Suspending a channel from a scan group](#)
- [Editing a scan group](#)

# About scanning

The scan feature is used to monitor groups of channels or talkgroups for activity of interest. This means that you are able to operate across multiple channels or talkgroups at the same time. For example, you may need to monitor your own conventional dispatch channel as well as other local area channels, such as a local sheriff and highway patrol channel.

Members of a scan group may be conventional channels (P25 or analog), trunked talkgroups, and vote groups, depending of the type of scan group. When scanning is active, the radio searches through member channels for activity. If activity is found, the radio remains on that channel or talkgroup, so that you can hear the activity, and respond if necessary. Once the activity has finished, the radio begins searching again.

Some channels or talkgroups, known as 'priority' channels or talkgroups, are scanned more often than others in the scan group. Calls from priority channels or talkgroups take precedence over those from non-priority group members.

While the radio is scanning for activity, the orange LED glows and the animated 📡 icon appears on the display.

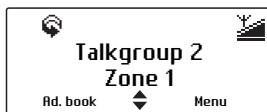

When the radio stops on a channel or talkgroup where there is activity, the orange LED and the 📡 icon flash.

In a background or talkgroup scan group, a scanning icon with a tick (📡) indicates that the selected channel or talkgroup is a member of the scan group.

The four types of scanning that may be available on your radio are:

- standard scanning (P25 conventional and analog channels)
- background scanning (P25 conventional and analog channels, and may include some voting groups)
- in-zone scanning (P25 conventional and analog channels, and P25 trunked talkgroups)
- talkgroup scanning (P25 trunked talkgroups, and may include some P25 conventional and analog channels,).

 For information about viewing and editing scan group membership, see ["Editing a scan group" on page 76](#).

## Activating standard scanning

A standard scan group scans conventional channels (P25 and analog) from across zones, and can also scan one or two voting groups. A standard scan group appears and behaves on the radio like a separate channel, and all standard scan groups are included in the channel list. Standard scanning is activated when you select a standard scan group.

To select a standard scan group:

- 1 Press **Menu** and select **Channels**.

(Depending on how your radio is programmed, you may be able to press a function key or use your Quick Access menu to select channels.)

- 2 Scroll to the group you want and press **Select**.

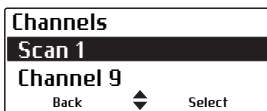

# Activating background scanning

A background scan group scans the group members, as well as the current channel selected on the radio. The group member channels can include conventional channels (P25 or analog) across zones, and can also include one or two voting groups.

Background scanning provides more flexibility than standard scanning, as the radio user can select a current channel to operate on, while still monitoring permanent group members for activity.

To turn background scanning on:

- Press **Menu** and select **Radio settings > Functions > Scanning**, or press the function key programmed for background scanning.

Background scanning remains on until you either press the function key again, or select a standard, in-zone or talkgroup scan group.

## Changing the background scan group assigned to the function key

- 1 Press **Menu** and select **Radio settings > Functions > Set scan key**.
- 2 Scroll through the list of background scan groups available and press **Select**. When you next turn on background scanning, this is the scan group that is activated.



# Activating in-zone scanning

An in-zone scan group scans the first 50 conventional channels (P25 or analog) or trunked talkgroups from the currently-selected zone. If you change zones, the radio stops scanning the previous zone's channels and automatically starts scanning channels from the new zone.

In-zone scanning is useful when scanning conventional channels and trunked talkgroups from within the selected zone, and zones are used to separate different geographic regions or work roles. As you change to a new region or role, you can change to another zone and the radio will automatically start scanning channels or talkgroups in the new zone, with no further action required.

To turn in-zone scanning on:

- Press **Menu** and select **Radio settings > Functions > Scanning**, or press the function key programmed for in-zone scanning.

In-zone scanning remains on until you either press the function key again, or select a standard, background or talkgroup scan group.

# Activating talkgroup scanning

Talkgroup scanning monitors calls from multiple trunked talkgroups, and up to five additional conventional channels (P25 or analog), from across zones. If conventional channels are included as group members, your radio will briefly leave the trunking control channel to scan these channels at regular intervals.



**Warning** If a **talkgroup scan group** contains P25 or analog conventional channels, scanning needs to exit trunk mode briefly to scan the conventional channels. **This may result in delayed or even missed calls!**

Talkgroup scanning is useful if you need to operate across multiple trunked talkgroups. When talkgroup scanning is activated, the currently-selected talkgroup or channel is temporarily included in the scan group. If you change zones, the radio continues to monitor group members as well as the currently selected talkgroup or channel from the new zone.

To turn talkgroup scanning on:

- Press **Menu** and select **Radio settings > Functions > Scanning**, or press the function key programmed for talkgroup scanning.

Talkgroup scanning remains on until you either press the function key again, or select a standard, background or in-zone scan group.

# Making a call while scanning

If you want to make a call while your radio is scanning:

- 1 Lift the microphone off the microphone clip.
- 2 Press the PTT key to transmit.

If the  icon and the orange LED are flashing, your radio calls the currently selected channel.

If there has been no recent activity on the channel (the  icon and the orange LED are on rather than flashing), then the channel that is called depends on the way your radio has been programmed.

The possible options are:

- your radio calls a predetermined channel e.g. your dispatcher
  - your radio calls the channel where activity was last detected
  - your radio calls the last free channel.
- 3 When the called party responds, proceed with your conversation.

# Suspending a channel from a scan group

If a group member is busy for a long time and you do not want to hear the conversation, you may be able to use the function key programmed for nuisance delete to temporarily delete the group member. When the scan group is next selected, or after the radio has been turned off and then on, the deleted member is again part of the scan group.

To temporarily remove a captured group member from the scan group:

- Press the function key programmed for nuisance delete.

If the channel has been removed successfully, the message **Channel nuisance deleted** appears in the display.

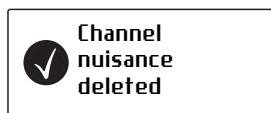

-  The function key programmed to activate scanning may be programmed so that a short key press activates scanning and a long key press activates nuisance delete.

## Editing a scan group

### Selecting a group to edit

- 1 Press **Menu** and select **Radio settings > Functions > Advanced > Edit groups**.



(Depending on how your radio is programmed, you may be able to press a function key or use your Quick Access menu to select the Edit Groups menu.)

The **Edit Groups** menu lists all scan groups programmed for your radio.

- 2 Scroll to the group that you want to view or edit, press **Select**.

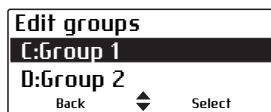

- 3 In the Edit Group menu, select from the following options:

- **Group members:** shows the current members of a group, and may also show the designated transmit channel and priority channels.
- **Add or Delete channel:** adds or deletes member channels of a group.
- **Change tx:** changes the group's transmit channel.
- **Change P1 or P2:** changes the group's first or second priority channel.

## Icons and messages

The following icons may appear when viewing group membership details, adding or deleting channels from a group, or changing a group's transmit or priority channels.

Icon	Meaning
$T_X$	This channel is used to transmit on when there has been no recent activity. You cannot delete this channel (it will not appear under <b>Delete channel</b> ).
$P_1$	This channel is the group's first priority channel. You cannot delete this channel (it will not appear under <b>Delete channel</b> ).
$P_2$	This channel is the group's second priority channel. You cannot delete this channel (it will not appear under <b>Delete channel</b> ).
+	There is more than one instance of this channel in the group (the channel will be scanned more often). If you delete this channel, the radio will attempt to delete all instances of the channel.

## Viewing group membership

- 1 In the **Radio settings** menu, select **Edit groups** and select a scan group. Press **Select**.
- 2 In the **Edit Group** menu, select **Group members** and press **Select**.



- 3 Scroll through the list of group members. The names of the group members may be shortened.
- 4 The information that may appear is explained in the example below.

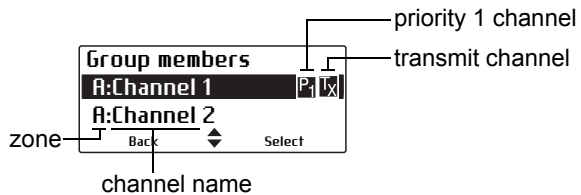



## Adding a channel to a group

- 1 In the **Radio settings** menu, select **Edit groups** and select a scan group. Press **Select**.
- 2 In the **Edit Group** menu, select **Add channel** and press **Select**.

A list of channels that are not group members appears.

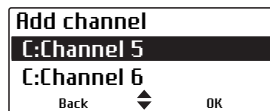
- 3 Select the channel you want to add and press **OK**.



-  For all types of scanning except standard scanning, if your radio is programmed to use the scroll keys to scroll through a list of channels and also has a function key programmed to Nuisance Delete, you can **permanently** add or delete a channel to the active group by scrolling to the channel and pressing the **Nuisance Delete** function key.

## Deleting a channel from a group

You cannot delete the priority 1 channel using the Delete Channel menu.

- 1 In the **Radio settings** menu, select **Edit groups** and select a scan group. Press **Select**.
- 2 In the **Edit Group** menu, select **Delete channel** and press **Select**.

A list of group members that are able to be deleted appears.

- 3 Select the channel you want to delete and press **OK**.

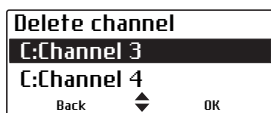

-  For all types of scanning except standard scanning, if your radio is programmed to use the scroll keys to scroll through a list of channels and also has a function key programmed to Nuisance Delete, you can **permanently** add or delete a channel to the active group by scrolling to the channel and pressing the Nuisance Delete function key.

## Changing a group's transmit channel



You can change the group's transmit channel only if it has been pre-programmed.

- 1 In the **Radio settings** menu, select **Edit groups** and select a scan group. Press **Select**.
- 2 In the **Edit Group** menu, select **Change tx** and press **Select**.

The current transmit channel is identified by the  $T_x$  icon beside the channel name.

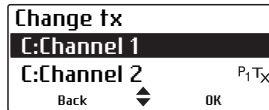

- 3 Select the new transmit channel and press **OK**.



The transmit channel remains changed even after the radio is turned off.

## Changing a group's first or second priority channel

- 1 In the **Radio settings** menu, select **Edit groups** and select a scan group. Press **Select**.
- 2 In the **Edit Group** menu, select **Change P1** or **Change P2** and press **Select**.

The current priority channels are identified by the  $P_1$  or  $P_2$  icons beside the channel names.

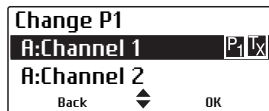

- 3 Select the new priority 1 or priority 2 channel and press **OK**.



# 7 P25 services

This section describes the P25 services that may be available on your radio.



This feature is controlled by a software license (SFE) and may not be available with your radio.

## **This section covers:**

- [Messages](#)
- [Status update](#)
- [Status request](#)
- [Call alert](#)
- [Radio check](#)
- [Radio unit monitor](#)
- [Radio inhibit and uninhibit](#)

# Messages

You may be able to send short messages to another radio user. These messages are defined at programming time.

If you are on a P25 trunk channel, you can send a message to any other radio on a trunk channel on the same network.

If you are on a P25 conventional channel, you can send a message to any other radio on the same conventional channel.

The radio to whom you are sending the message must have the same message programmed in order to read and display your message.

## Sending a message

You may be able to send your message to a predetermined person or to the dispatcher administering the current talkgroup, or to a person of your choice.

### Sending a message to a predetermined person or talkgroup administrator

- 1 Press **Menu** and select **Services > Messages**.
- 2 Select the message you want from the list.
- 3 Press **Select**.

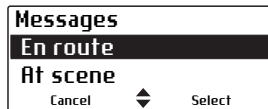

A message showing the destination appears in the display.



The red LED glows and a message may be displayed to advise you whether the message has been sent successfully or not.

If an acknowledgement is not received from the recipient's radio, you will have the option of either canceling or resending the call alert page.

## **Sending a message to a person of your choice**

- 1 Press **Menu** and select **Services > Messages**.  
(Depending on how your radio is programmed, you may be able to press a function key or use your Quick Access menu to select messages.)
- 2 Select the message you want from the message list.
- 3 Press **Select**.

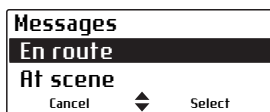

- 4 Select the message recipient from the list and press **Send**.



A message showing the destination briefly appears in the display.



The red LED glows and a message may be displayed to advise you whether the message has been sent successfully or not.

If an acknowledgement is not received from the recipient's radio, you will have the option of either canceling or resending the request.

# Status update

You can inform another radio user of your current status by sending them a status update, for example, 'At scene'. You may be able to send the status update to a predetermined person or talkgroup, or to a person of your choice.

If you are on a P25 trunk channel, you can send your status to any other radio on a trunk channel on the same network.

If you are on a P25 conventional channel, you can send your status to any other radio on the same conventional channel.

When you send a status message, you are also *setting* your status, which the dispatcher may be able to check by 'interrogating' your radio. You can change your status at any time by selecting another status message and sending it. See "[Status request](#)" on [page 85](#).

To send a status update:

- 1 Press **Menu** and select **Services** > **Status update**. (Depending on how your radio is programmed, you may be able to press a function key or use your Quick Access menu to select status update.)
- 2 Select the status message you want from the list.
- 3 Press **Send** or **Select**.

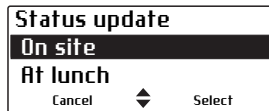

A message showing the destination appears in the display.



The red LED glows and a message may be displayed to advise you whether the status update has been sent successfully or not.

If an acknowledgement is not received from the recipient's radio, you will have the option of either canceling or resending the request.

## Status request

This feature is only available on P25 conventional channels.

You can find out what another radio user is currently doing by asking their radio to send you a status update.

To send a status request:

- 1 Press **Menu** and select **Services > Status request**.
- 2 Select the status request recipient from the list.
- 3 Press **Send to**.

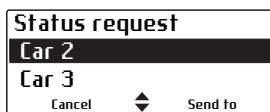

A message showing the destination appears in the display.



The red LED glows briefly. If the request was successful, a message showing the status appears in the display.



If an acknowledgement is not received from the recipient's radio, you will have the option of either canceling or resending the request.

## Call alert

You can let another radio user know that you want to talk to them by sending them a call alert page. When the other radio user receives the call alert page, they can call you back when it is convenient.

If you are on a P25 trunk channel, you can send a call alert to any other radio on a trunk channel on the same network.

If you are on a P25 conventional channel, you can send a call alert to any other radio on the same conventional channel.

To send a call alert page:

- 1 Press **Menu** and select **Services > Call alert**.
- 2 Select the radio you want to page.
- 3 Press **Send to**.



A message appears in the display.



The red LED glows and a message may be displayed to advise you whether the call alert has been sent successfully or not.

If an acknowledgement is not received from the recipient's radio, you will have the option of either canceling or resending the request.

## Answering a call alert page

If you receive a call alert page from another radio user, the message **Page rx'd from...** briefly appears in the display.

Select **Call** to return the page or **No** to delete it. If you miss the call alert page, the identity of the caller may be saved in your recent calls list.

## Radio check

This feature is only available on P25 conventional channels.

If you want to find out whether a particular radio is available on the system, you can use the radio check feature. This sends a radio check message to the radio unit you have specified.

- 1 Press **Menu** and select **Services > Radio check**.
- 2 Scroll to the radio you want to check.
- 3 Press **Send to**.

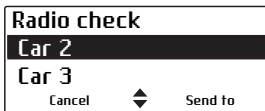

The red LED glows and a message showing the destination appears in the display.



If the radio is available on the system, an acknowledgement message is displayed.



If an acknowledgement is not received from the recipient's radio, you will have the option of either canceling or resending the request.

## Radio unit monitor

-  This feature is controlled by a software license (SFE) and may not be available with your radio. This software license is only required for the radio that sends the radio unit monitor request. The receiving radio does not need the software license.

This feature is only available for digital channels operating in conventional mode, and for radios configured for dispatcher operation.

The radio unit monitor feature can be used when you are concerned about the safety of a radio user on your system. When you send a radio-unit monitor request to a radio, it calls you back without giving any indication that it is making a call. You can hear any activity near the radio for up to 20 seconds.

### Sending a radio unit monitor request

- 1 Press **Menu** and select **Services > Radio monitor**.
- 2 Scroll to the radio you want to monitor.
- 3 Press **Send to**.

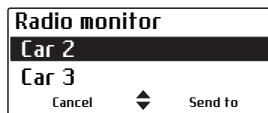

The red LED glows and a message appears in the display.

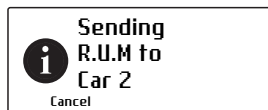



If the other radio has received your request, it will now call you, so that you can monitor activity near the radio.

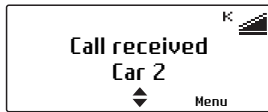

If an acknowledgement is not received from the recipient's radio, you will have the option of either canceling or resending the request.

## Radio inhibit and uninhibit



**Warning** When your radio is immobilized ('inhibited'), your encryption keys may be automatically deleted from your radio.

This feature is only available for digital channels operating in conventional mode, and for radios configured for dispatcher operation.

If you want to make another radio on the system inoperable, you can use the radio inhibit feature. This feature is also known as 'stun'.

To the user of the inhibited radio, it appears as though the radio has turned off. The radio remains inoperable even if it is turned off and then on again.

The radio cannot return to operation until it receives an uninhibit request. This is also known as 'revive'.

### Sending a radio inhibit request

- 1 Press **Menu** and select **Services > Radio inhibit**.
- 2 Scroll to the radio you wish to make inoperable.
- 3 Press **Send to**.



The red LED glows and a message appears in the display.

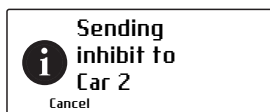

If the radio has been successfully immobilized, an acknowledgement message is displayed.

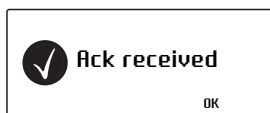

### **Sending a radio uninhibit request**

- 1 Press **Menu** and select **Services > Radio uninhibit**.
- 2 Scroll to the radio you wish to make operable.
- 3 Press **Send to**.

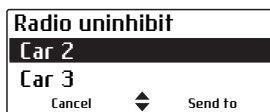

The red LED glows and a message appears in the display.

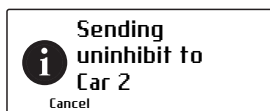

If the radio has been successfully returned to operation, an acknowledgement message is displayed.

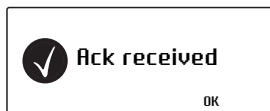

If an acknowledgement is not received from the recipient's radio, you will have the option of either canceling or resending the request.

# 8 Location services

This section explains how to use the location services that may be available on your radio.



This feature is controlled by a software license (SFE) and may not be available with your radio.

## **This section covers:**

- [About location information](#)
- [About location statuses](#)
- [Viewing location information](#)
- [Sending location information](#)
- [Receiving and logging location information](#)
- [Accessing logged location information](#)

# About location information

While you may be able to view your location information on analog channels, sending location information is only available for digital channels.

If your radio is connected to the receiver of a satellite navigation system, you can view location information such as latitude and longitude, true course, speed, and coordinated universal time. Your radio can also display universal transverse mercator (UTM) information such as the UTM zone, and northing and easting coordinates.

Your radio may also be set up to send or receive and log location information.

# About location statuses

In the **Own location** screen, location status information appears at the top right of the display.

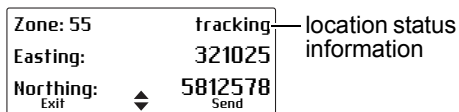

Status information shown on a hand-held control head is shown in brackets [ ].

- **tracking [Trk]**: the receiver is displaying up-to-date satellite information.
- **stored**: the receiver is having trouble connecting to satellites and the radio is displaying stored information that may not be current.
- **lost cnx [no cnx]**: the radio has lost serial communications with the receiver.

Your radio configuration may include the **Send** option. This option is a digital feature, and is only available on digital channels.

# Viewing location information

- 1 Press **Menu** and select **Location Svs > Own location**.

(Depending on how your radio is programmed, you may be able to press a function key to access the **Own location** menu.)

Location information is now shown in the display, if it is available.

 Your radio may be programmed to show any of these displays, in any order.

- 2 Use the scroll keys to scroll through the **Own location** displays.

<b>Zone: 59</b>	tracking
Easting:	321025
Northing:	5812578
Exit	◆

- Zone: UTM zone number
- Easting and Northing: Raw Universal Transverse Mercator (UTM) Cartesian coordinates

<b>Location</b>	tracking
S	43°29'00.0"
E	172°33'05.0"
Exit	◆

- Latitude and longitude in degrees, minutes and decimal seconds

<b>Location</b>	tracking
S	43°29.000"
E	172°33.083"
Exit	◆

- Latitude and longitude in degrees, minutes and decimal minutes (to three decimal places)

<b>Location</b>	tracking
S	43.488326°
E	172.563255°
Exit	◆

- Latitude and longitude in decimal degrees

<b>Location</b>	tracking
Course:	010°
Speed:	045 km/h
Exit	◆

- The radio's current course and speed

<b>Location</b>	tracking
UTC time:	23:36:20
Exit	◆

- UTC: Coordinated Universal Time 24 hour clock

<b>Location</b>	tracking
Altitude:	34m
Exit	◆

- The radio's altitude in metres above or below mean sea level

<b>MGA:</b>	tracking
Zone:	29N
Exit	◆ PJ264837

- MGA: Map Grid of Australia coordinate system
- Zone: UTM zone number
- PJ: The grid square
- 264837: Easting and Northing to the nearest 100m

<b>MGRS:</b>	tracking
59G PM	
26406 83789	
Exit	◆

- MGRS: Military Grid Reference System
- 59G: UTM zone and band
- PM: The grid square
- 26406 83789: Easting and Northing to the nearest 1 m

### 3 Press **Exit** to exit the location display.

In certain situations, your radio may automatically exit the location display.

## Sending location information

 This feature is controlled by a software license (SFE) and may not be available with your radio.

To send location information, you can:

- press the PTT key,
- use a function key, or
- use the radio menu.

### Using the PTT key

Your radio may be configured to send location information each time you press or release the PTT key. This feature can be turned on or off using the Send On PTT menu, and may be active when the radio is first turned on.

To turn 'Send on PTT' off or on:

- 1 Press **Menu** and select **Location Svs > Send on PTT**.

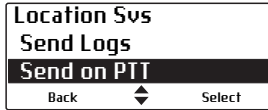

- 2 Scroll to **Off** (or **On**) and press **Select**. (The current setting is highlighted.)

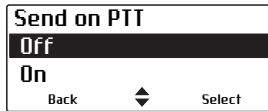

## Using a function key

You may be able to use a function key to manually send your location to either all radios on the channel, or to your dispatcher (depending on how your radio is programmed).

- 1 Press the function key programmed for **Own Location**.

(Alternatively, press **Menu** and select **Location Svs > Own location**.)

The current location of the radio appears on the display.

- 2 Press **Send**.

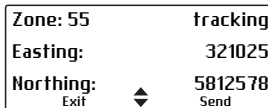

The message **Location sent** briefly appears in the display.



# Receiving and logging location information

 This feature is controlled by a software license (SFE) and may not be available with your radio.

When your radio receives location information, the display shows **Location**, along with the digital 'alias' of the sending radio. If the radio alias is not available, the radio ID appears.

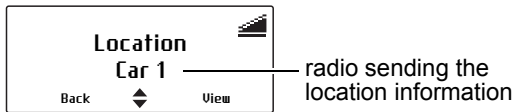

The location information can then be viewed and logged. The most recent location details of up to 10 radios will be available, until the radio is turned off.

Updated information from a previously logged radio is automatically stored by your radio, without first being viewed.

To display and log the received location of a radio:

## 1 Press **View**.

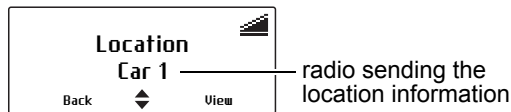

The location information appears in the display.

## 2 Press **Add** to add the radio to your Team Locations.

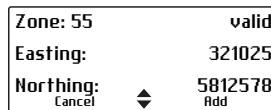

The message **Terminal added** briefly appears on the display.



-  Radios can also be added to Team Locations by pressing **Menu**, selecting **Location Svcs > Team Locations**, pressing **Options** and selecting **Add**; then select whether to add a radio from the **Recent talkers** list, or by entering a **Dialed number**.

## Accessing logged location information

-  This feature is controlled by a software license (SFE) and may not be available with your radio.

### Accessing Team Locations

You can use the **Team Locations** menu option to display the latest location information received by added devices. To view a radio's logged location information:

- 1 Press **Menu** and select **Location Svcs > Team Locations**.
- 2 Scroll to the radio you want and press **Options**.



- 3 Select **View**.

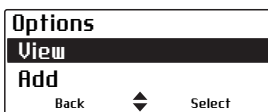

The latest location information available for that radio appears.

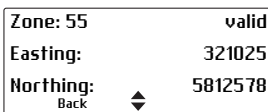

- 4 Use the up and down scroll keys to view the location display options that have been configured.



Select **Delete** from the **Options** menu to remove the location information for the radio, and stop logging it.

## Accessing Recent Locations

The latest location data received, including **Team Locations**, can be viewed using the **Recent Contacts** menu option. Up to 10 entries will be available. To view the **Recent Contacts** information:

- 1 Press **Menu** and select **Location Svs > Recent Contacts**.
- 2 Scroll down to the contact you want and press **View**.



The latest location information available for that radio appears.

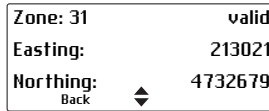

- 3 Use the up and down scroll keys to view the location display options that have been configured.



# 9 Emergency operation

This section describes how to make different types of emergency calls.

**This section covers:**

- [About emergency calls](#)
- [Making a priority call](#)
- [Standard emergency mode](#)
- [About manual emergency operation](#)
- [Accessing emergency location information](#)
- [Loneworker monitoring](#)

# About emergency calls



**Warning** When emergency mode is activated, your encryption keys may be automatically deleted from your radio.

In an emergency you can summon help by sending an emergency call. There are three types of emergency calls:

Call type	Explanation
Priority call	(Digital channels only.) An emergency alert is automatically sent to the current talkgroup. Calls made when the priority call feature is turned on are flagged as 'emergency' calls. For further information see " <a href="#">Making a priority call</a> " on page 101.
Standard emergency call	When an emergency call is initiated, the radio enters 'emergency mode'. For further information see " <a href="#">Standard emergency mode</a> " on page 102.
Manual emergency call	(Digital channels only.) Emergency is activated and your radio sends an alert to your dispatcher and other members of your group, along with your radio digital alias and location. For further information see " <a href="#">About manual emergency operation</a> " on page 105.

# Making a priority call

This feature is available for digital channels only.

When you turn the priority call feature on, the radio automatically sends an emergency alert (message) to the current talkgroup.

Any calls you make while the priority call feature is turned on are flagged as emergency calls.

To turn the priority call feature on and off:

**1 Press **Menu** and select **Priority call**.**

(Depending on how your radio is programmed, you may be able to press a function key to turn priority call on and off.)

**2 Scroll to **On** (or **Off**) and press **Select**.**



# Standard emergency mode

When you press the emergency key your radio enters 'emergency mode', if your radio is programmed in this way.

When the radio enters emergency mode, it will automatically send alerts together with your radio unit ID to the dispatcher. These alerts are usually sent on a designated emergency channel.



**Warning** The way your radio behaves in emergency mode depends on how your radio is programmed.

For further information on what your radio may do in emergency mode, see ["What happens during an emergency call?" on page 103.](#)

## Stealth and non-stealth emergency modes

Your radio is programmed to operate in one of these ways:

- **Stealth:** you often work in situations where you do not want an assailant to know that you have activated emergency mode. For this reason, the radio is silent and the display remains unchanged—there is no indication that the radio has entered emergency mode.

An optional feature of stealth emergencies is false powerdown ('keep alive'). When an unauthorized person attempts to prevent you from using your radio by turning it off, the radio *appears* to turn off. However, the radio is still in emergency mode.

- **Non-stealth:** you often work in situations where you want audible and visual confirmation that you have activated emergency mode (for example, at an accident scene).

# What happens during an emergency call?

The *exact* way your radio behaves when it enters emergency mode depends on how your radio is programmed.

The main phases for both stealth and non-stealth emergency modes are summarized below. The length of each phase is determined when the radio is programmed.

When the emergency key is pressed:

①

Digital channels: the radio continually sends emergency alerts to the dispatcher until a response is received. Details of your location may also be sent (if this feature is available for your radio).



②

The radio alternately transmits and receives so the dispatcher can hear what is happening in the vicinity of your radio.

(Non-stealth emergencies end once this phase is complete or when you end emergency mode.)



③

Stealth emergencies only: The radio is inactive, but it can receive special 'messages' from the dispatcher so that he or she can hear what is happening in the vicinity of the radio.

(Stealth emergencies end once this phase is complete or when you end emergency mode.)

See also "[Stealth and non-stealth emergency modes](#)" on page 102.

## Activating emergency mode

You can activate emergency mode using the emergency function key or a hidden switch, if your radio is set up in this way.

- 1 Long press the function key or hidden switch to activate emergency mode.

In non-stealth emergencies, 'Emergency mode' appears in the display.

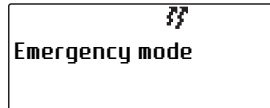

One or more emergency calls are sent to your dispatcher or another predetermined radio user. During emergency mode, the radio will behave as described in "[What happens during an emergency call?](#)" on page 103.



**Warning** If your microphone is removed or damaged by an assailant, you still may be able to communicate with the dispatcher using the concealed microphone. This microphone is hidden behind the speaker and can only be used during emergency mode, if your radio is programmed in this way.

- 2 Turn the radio off and on again to end emergency mode (including 'false powerdown'). The radio returns to normal operation.



# About manual emergency operation

This feature is available for digital channels only.

When you press the emergency key, your radio sends an alert to your dispatcher and other members of your group, along with your radio digital alias and location.

While the emergency call is active, the emergency information is sent out periodically, until either you or another member of your group end the emergency call.

You are still able to make and receive voice calls while emergency information is being sent, but your radio does not display caller details.

## Making a manual emergency call



**Warning** You will not be able to make a voice call on the channel until the 3-second emergency alarm has finished.

- 1 Press and hold the emergency key for longer than three seconds.

The radio gives three short beeps, rising in pitch.

**Emergency** appears in the display, and remains until the manual emergency call is canceled.

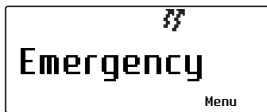

If you receive an acknowledgement from another radio in your group, the manual emergency call is canceled, and the message **Emergency Acked** briefly appears in the display.

 This feature is controlled by a software license (SFE) and may not be available with your radio.

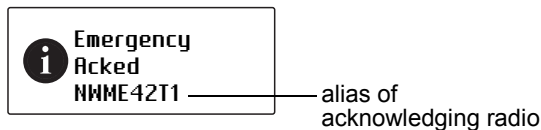

## Receiving a manual emergency call

When your radio receives a manual emergency call, **Emergency** appears in the display, along with the identity of the radio that initiated the emergency call.

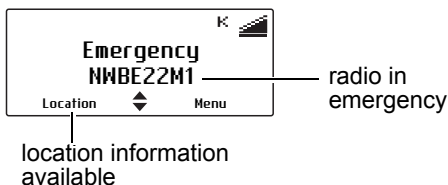

A loud repeating emergency alarm sounds for three seconds. If location information has been sent, **Location** appears in the display.

## Canceling a manual emergency call

If the emergency situation has been resolved, the manual emergency call can be canceled either by you or another member of your group.

### Canceling an emergency call you have made

- Press and hold the emergency key for longer than three seconds.

The message **Emergency canceled** appears in the display.

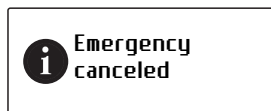

Your radio now returns to the channel that it was operating on prior to the emergency call.

## Canceling a manual emergency call you have received

When you have received a duress emergency call, the Emergency menu always moves to the top of the menu list. In the Emergency Menu, you can manually acknowledge the duress emergency call. This acknowledgement cancels the call.

- 1 Press **Menu** and select **Emergency > Acknowledge**.

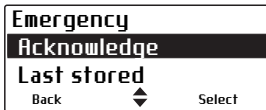

The name of the radio that initiated the emergency call appears in the display.

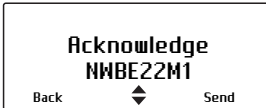

- 2 Press **Send** to cancel the manual emergency call from that number.

The message **Emergency ack. sent** briefly appears in the display.

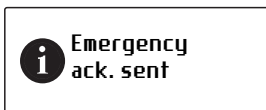

# Accessing emergency location information

If **Location** appears in the display, above the left selection key, you can display the current location of the radio that has sent a manual emergency call. The last location of the radio will still be available even if the radio is turned off and then on again.

To access the location information, either press **Location** or use the Last Stored menu.

## Using the Location menu

- 1 Press **Location** to display the current location of the radio.

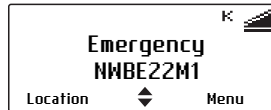

- 2 Use the scroll keys to view more location information.

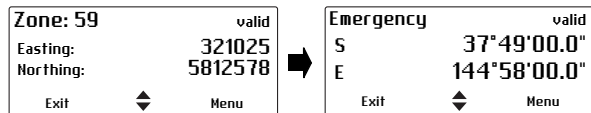

- 3 Press **Exit** to return to the previous display.

## Using the Last stored menu

- 1 Press **Menu** and select **Emergency > Last stored** to display the current location of the radio.

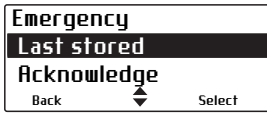

- 2 Use the scroll keys to view more location information.

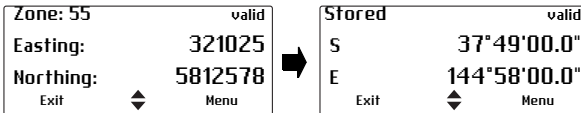

- 3 Press **Exit** to return to the previous display.

## Loneworker monitoring

Loneworker monitoring is a safety feature for people who work alone. Loneworker monitoring may be programmed to be on or off at all times, or can be switched on and off by the user using a programmed function key or the menu.

A loneworker alarm is activated, if there has been no user activity for a predetermined time.

When the predetermined time has expired, an audible warning is given and you have a predetermined time to respond to the loneworker situation.

If you are unable to respond, the radio either enters emergency mode or (in trunked mode) sends a status update to a predetermined person or talkgroup.

## Activating loneworker monitoring

- 1 Press **Menu** and select **Radio Settings > Extra features > Loneworker**. (Depending on how your radio is programmed, you may be able to press a function key to turn loneworker monitoring on and off.)



- 2 In the Loneworker menu, choose **On**.

A vertical scroll bar on the right-hand side of the display indicates the remaining activity timeout.

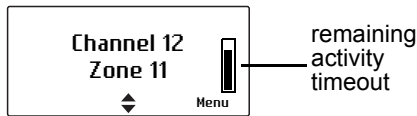

## Responding to a loneworker alarm

You hear a beep indicating that the radio is expecting a response from you to acknowledge that you are safe. The message **Loneworker awaiting** and a horizontal scroll bar appear indicating the remaining time until an emergency action is triggered.

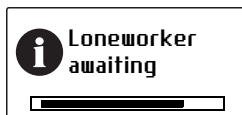

- Press any key.

Otherwise the radio will activate emergency mode or (in trunked mode) send a status update.

# 10 Encryption

This section describes how to use encryption to make your communications completely private.

 This feature is controlled by a software license (SFE) and may not be available with your radio.

## **This section covers:**

- [About encryption](#)
- [Encrypting calls](#)
- [Making an encrypted call](#)
- [Receiving an encrypted call](#)
- [Changing the radio's encryption key](#)
- [Removing encryption keys from the radio](#)
- [Updating encryption keys over-the-air](#)

# About encryption

The encryption feature is available for digital and dual-mode channels only.

To make communications with other users on your system completely private, your radio may be able to encrypt outgoing calls, using a confidential encryption key. The radio receiving your call must have the same encryption key installed before it can hear your encrypted call.

## About the proper key detect feature

Your radio may be programmed with 'proper key detect'. This means that you can only hear an encrypted call if the key used to encrypt the incoming call matches the key used to encrypt your outgoing calls on that channel.

Note that encryption does not need to be turned 'on' for the radio to unmute.

For example, you are encrypting your outgoing calls using encryption **key 7**. Although **key 1** and **key 2** are also stored in your radio, your radio has been programmed so that it will only unmute for incoming calls encrypted using **key 7**.

# Encrypting calls

Your radio may be able to turn encryption on and off. While encryption is on, your outgoing calls are encrypted on channels programmed for encryption, and the encryption icon  remains in the display.

This setting only affects outgoing calls. Incoming calls will still be decoded by your radio so long as the key required to decode the call is stored in your radio.



To turn encryption on or off:

- 1 Press **Menu** and select **Security > Encryption**.  
(Depending on how your radio is programmed, you may be able to press a function key to turn encryption on and off.)
- 2 Scroll to **On** (or **Off**) and press **Select**.

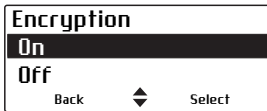



The message **Encryption activated** (or **deactivated**) appears in the display.

## Making an encrypted call

- 1 Select the channel or group you wish to call.
- 2 Check that encryption is on (  is showing in the display).
- 3 Press and hold the PTT key to transmit.

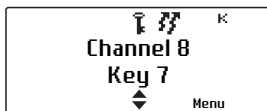
The name of the encryption key that your radio is using for the transmission may briefly appear in the display.



While you are transmitting, the red LED glows and  appears in the display.

## Receiving an encrypted call

When you receive an encrypted call, your radio unmutes and you can hear clear speech, so long as the key required to decode the call is stored in your radio.

The name of the encryption key used to encrypt the incoming call may briefly appear in the display, below the name of the caller.

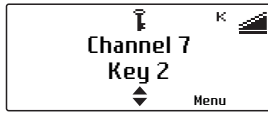

If the key required to decode the call is not stored in your radio, then your radio remains muted.

Your radio may also remain muted if the currently selected channel has 'proper key detect' programmed.

## Changing the radio's encryption key

You may be able to use the **Change All** menu to change the encryption key that encrypts your outgoing calls. You can then use the **Preset Keys** menu to change the encryption keys back to the default encryption key for each channel.



**Warning** Once you change the encryption key, it may also automatically update the encryption keys used to encrypt calls on other channels.

## Changing the transmit encryption key

- 1 Press **Menu** and select **Security > Change all**.
- 2 Scroll to the key you want and press **Select**.



The message **Global key selected** briefly appears in the display.

# Changing the transmit encryption key back to the default setting

- 1 Press **Menu** and select **Security** > **Preset keys**.



The message **Select preset keys?** appears in the display.

- 2 Press **OK** and the message **Preset keys selected** briefly appears in the display.

# Changing the encryption keyset

It may be possible for you to change the encryption data associated with the encryption keys loaded in your radio.

- 1 **Menu** and select **Security** and select **Security** > **Change keyset**.
- 2 Scroll to **01** or **02** and press **Select**.



The message **Keyset selected** briefly appears in the display.

# Removing encryption keys from the radio

It may be possible for you to delete encryption keys from your radio.



**Warning** When emergency mode is activated, or when your radio is immobilized ('inhibited'), your encryption keys may be automatically deleted from your radio.

## Deleting an encryption key

- 1 Press **Menu** and select **Security > Advanced > Zeroize key**.
- 2 Scroll to the key you want and press **Select**.

The message **Single key zeroized** briefly appears in the display.

## Deleting all encryption keys

- 1 Press **Menu** and select **Security > Advanced > Zeroize all**.

The message **Zeroize all keys?** appears in the display.

- 2 Press **OK** and the message **All keys zeroized** briefly appears in the display and  no longer appears.

# Updating encryption keys over-the-air

You may be able to update your encryption keys using over-the-air-rekeying (OTAR).

 This feature is controlled by a software license (SFE) and may not be available with your radio.

This feature is only available for digital channels operating in conventional mode.

- Press **Menu** and select **Security > Rekey request**.

The message **Rekey request ack** appears in the display. If there is no response to the rekey request, the message **Rekey request timeout** appears.

# 11 Customizing radio settings

This section describes the ways in which you can customize your radio.

## **This section covers:**

- [Reducing power consumption](#)
- [Changing the volume of all audible indicators](#)
- [Changing the volume of keypress tones](#)
- [Changing to quiet operation](#)
- [Changing to silent operation](#)
- [Changing the external alert option](#)
- [Turning on backlighting](#)
- [Adjusting the display contrast](#)

# Reducing power consumption

You can reduce the power consumption of your radio (and thereby reduce the drain on your vehicle battery) in the following ways:

- Transmit at low power (if your radio is not already configured to do this).
- Turn off backlighting when it is not required (see ["Turning on backlighting" on page 122](#)).

## Turning low power transmit on or off

If you are using your radio in conditions where signal strength is high, you can reduce the drain on your vehicle battery by transmitting at low power.

When low power transmit is turned on,  appears in the display and calls are made at low power rather than at the programmed power setting.

Some channels may always transmit at low power.

To turn low power transmit on or off for all channels:

- 1 Press **Menu** and select **Radio settings > Functions > Low power tx**.

(Depending on how your radio is programmed, you may be able to press a function key to turn low power transmit on or off.)

- 2 Scroll to **On** (or **Off**) and press **Select**. (The current setting is highlighted.)

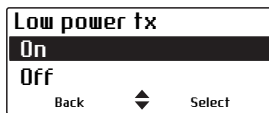

The message **Low power tx activated** (or **deactivated**) appears in the display.

# Changing the volume of all audible indicators

You can set the volume of all the audible indicators to either high or low. Audible tones include incoming call tones, warning tones and confirmation tones.

To change the volume of your radio's audible tones:

- 1 Press **Menu** and select **Radio settings > Alert settings > Indicator level**.

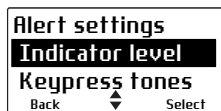

(Depending on how your radio is programmed, you may be able to press a function key to change the level of indicators.)

- 2 Scroll to **High** (or **Low**) and press **Select**.

# Changing the volume of keypress tones

Whenever you press the radio keys, the keypress tones give you an audible indication as to whether or not your action is allowed. A short, medium-pitched beep indicates that an action is allowed. A long, low-pitched beep indicates that the action is not allowed.

To change the volume of your radio's keypress tones:

- 1 Press **Menu** and select **Radio settings > Alert settings > Keypress tones**.

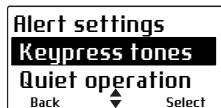

- 2 Scroll to either **Off**, **Low** or **High** and press **Select**.



# Changing to quiet operation

When quiet operation is on, keypress tones and confirmation tones are turned off. Incoming call tones, signaling tones and warning tones all remain audible.

To turn quiet operation on or off:

- 1 Press **Menu** and select **Radio settings** > **Alert settings** > **Quiet operation**.

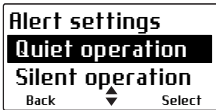

(Depending on how your radio is programmed, you may be able to press a function key to toggle quiet operation on and off.)

- 2 Scroll to **On** (or **Off**) and press **Select**.

# Changing to silent operation

When silent operation is on, all the radio's audible tones are turned off, and only channel traffic can be heard.

To turn silent operation on or off:

- 1 Press **Menu** and select **Radio settings** > **Alert settings** > **Silent operation**.

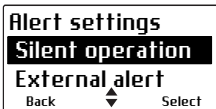

- 2 In the Silent Operation menu, scroll to either **On** or **Off** and press **Select**.

(Depending on how your radio is programmed, you may be able to press a function key to toggle silent operation on and off.)

While silent operation is on, the  icon appears in the display.

# Changing the external alert option

If you are away from your radio and unable to answer calls immediately, an external alert, such as a car horn, may activate when you receive a call. The external alert continues for a period of time and is then turned off.

To turn external alert on or off:

- 1 Press **Menu** and select **Radio settings** > **Alert settings** > **External alert**.



(Depending on how your radio is programmed, you may be able to press a function key to toggle external alert on and off.)

- 2 Scroll to either **On** or **Off** and press **Select**.

# Turning on backlighting

Whenever a key is pressed or a call is received, the keypad and display light up automatically. Backlighting only remains on for a few seconds, unless there is further radio activity. When backlighting is turned on, it remains on until the setting is changed to **Off**, regardless of radio activity.

To turn backlighting on or off:

- 1 Press **Menu** and select **Radio settings** > **Display settings** > **Backlighting**.



(Depending on how your radio is programmed, you may be able to press a function key to toggle backlighting on and off.)

- 2 Scroll to either **On** or **Off** and press **Select**.

## Turning backlighting on momentarily

You may be able to use a programmed function key to turn backlighting on momentarily.

- Press the assigned function key to turn backlighting on. Backlighting remains on for a few seconds, and then turns off.

Alternatively, the function key may be programmed so that:

- a short key press turns backlighting on momentarily, and
- a long key press turns backlighting on, and it remains on until there is a further long key press.

## Adjusting the backlighting level

The radio's display can also be made either darker or lighter, to suit your working conditions.

To change the level of the backlighting:

- 1 Press **Menu** and select **Radio settings** > **Display settings** > **Backlight level**.



- 2 Scroll to either **Low**, **Medium** or **High**, and press **Select**.

# Adjusting the display contrast

To change the contrast of your radio display to suit the lighting conditions that you are working in:

- 1 Press **Menu** and select **Radio settings** > **Display settings** > **Contrast adjust**.

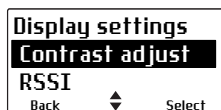

- 2 Use the scroll keys to adjust the display contrast to the level you want.



- 3 Press **Save** to save this setting.

# 12 Troubleshooting

This section describes troubleshooting procedures, and basic maintenance.

If you are experiencing difficulty operating your radio, you may find the following sections helpful. Consult your radio provider for assistance, if necessary.

## **This section covers:**

- [When the radio won't turn on](#)
- [Identifying the radio's audible tones](#)
- [Viewing radio information](#)
- [Changing the radio ID](#)
- [Running diagnostics tests](#)
- [Removing the microphone](#)
- [General care](#)

# When the radio won't turn on

If the red, green and orange LEDs on the control head do not light up briefly when the radio is turned on, it is probable that power is not reaching the radio. Check the following:

- Is the power connector firmly plugged into the rear of the radio?
- Are the in-line fuses in good condition?
- Is the power cable securely connected to the vehicle battery or power supply?

If all appears to be in order, but your radio still fails to operate properly, contact your radio provider for further assistance.

# Identifying the radio's audible tones

The radio's audible tones can help you identify a potential problem. See ["Audible tones" on page 29](#).

# Viewing radio information

Use the **Radio info** menu to view information such as the hardware and firmware version of your radio, function key settings, the radio serial number, and various radio identities.

- 1 Press **Menu** and select **Radio settings > Radio info**.
- 2 Scroll to the radio information you want to view and press **Select**.

## Checking the version of your radio using the PTT key (not with hand-held control head)

- 1 Turn off the radio.
- 2 Hold down the PTT key and turn on the radio.

The firmware and hardware versions, and your radio's frequency band is briefly displayed.

## Changing the radio ID

You can change the radio ID if the current ID is not correct.

 To change the radio ID your radio must have alphanumeric keys.

- 1 Press **Menu** and select **Radio settings** > **Radio info** > **Radio ID**.
- 2 Press the right selection key.
- 3 If **Enter PIN** appears in the display, enter the correct sequence of keys (known as the technician access PIN).
- 4 Press **Clear** to delete the current ID, and use a combination of the scroll keys and alphanumeric keys to enter a new ID.
- 5 Press **Options** > **Store** to save the new ID.

## Running diagnostics tests

Diagnostics tests are available via the main menu.

 This feature is controlled by a software license (SFE) and may not be available with your radio.

- 1 Press **Menu** and select **Diagnostics**.
- 2 Scroll to the name of the test you want to run and press **Select**.

The following table lists diagnostics tests you may find on your radio.

**Notice** The radio may transmit when you select some tests. Make sure you have a suitable load or antenna connected before running diagnostics tests.

<b>Test</b>	<b>Description</b>
Audio loopback test	Routes audio from the microphone to the radio's internal and external speakers. Before running this test, turn the volume down to limit interference and reduce the impact of audio artefacts.
Display freq	Displays the transmit and receive frequencies of the current channel. Also displays the channel status (CNV, TCH, CCH <sup>1</sup> ) and the mode (ANA, PH1 or PH2 <sup>2</sup> ). If the radio is scanning this information may not be available.
GPS NMEA data	Displays the last raw data received from a GPS antenna/receiver connected to the radio. The radio will display all supported sentence formats received (for example \$GPRMC and \$GPGGA sentences). Note that the display will not automatically refresh when new data is received.
Keypad test	Sounds an audible tone when a key is pressed or released on the radio. The radio also displays the key name along with "pressed" or "released".
QoS (P25 channels only)	Displays information about the quality of service (received signal strength (RSSI) with an indication of digital voice quality). Also displays the channel status (CNV, TCH, CCH <sup>1</sup> ) and the mode (PH1 or PH2 <sup>2</sup> ).
RSSI	Displays the received signal strength (RSSI) of the current channel.
Rx Tone	Receives a 1011Hz or 1031Hz tone and displays the received signal strength (RSSI) and the bit error rate (BER) of the received signal. Also displays the channel status (CNV, TCH, CCH <sup>1</sup> ) and the mode (PH1 or PH2 <sup>2</sup> ). On a P25 conventional channel, the user can select whether to receive a 1011Hz (Phase 1) or 1031Hz (Phase 2) tone. On a P25 trunked channel, the network selects whether 1011Hz or 1031Hz is used.
Site display	Shows the channel number, signal strength and system-identity code (SYSCODE) for the currently registered trunked site.
Site measure	Lists the current trunked site (indicated with an asterisk) and up to six detected adjacent sites, with received signal strength (RSSI) information.
Tone test	Generates an audible tone for the duration of the test.



Test	Description
Tx Tone	Transmits a tone of 1011Hz or 1031Hz on the current P25 channel.
Tx Tone Cal	Transmits a 1011Hz or 1031Hz tone on the current channel with a bit error rate (BER) of 5%.
Tx power test	Displays hardware-related information while the radio is transmitting. Information includes the final PA current (in mA), and estimated forward and reverse power levels (in W) along with an indication of (OK) or (!)

1. CNV=conventional, TCH=traffic channel, CCH=control channel
2. ANA=analog, PH1=P25 Phase 1, PH2=P25 Phase 2

## Removing the microphone

 For information on installing or removing your radio from a vehicle, refer to the Installation Guide.

- 1 Using your thumb or forefinger, lift up one of the corners of the microphone grommet and firmly (but gently) pull that corner until the seal comes away from the cavity.

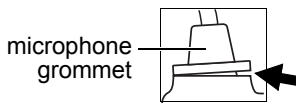

**Notice** Remove the grommet carefully as it serves two important functions. Firstly, it prevents damage to the microphone socket due to movement of the microphone cord, and secondly, it ensures that the control head is sealed against water, dust, and other environmental hazards.

- 2 Repeat to expose another corner.
- 3 Pull the exposed corners back and slide the grommet up the cable to reveal the microphone plug.
- 4 Remove the plug from the microphone socket.

# General care

Your radio requires no regular maintenance other than ensuring that all the cables and connections are secure, and that no damage has occurred to the antenna or wiring.

**Notice** To prevent permanent damage to the radio cover, do not allow the radio to come into contact with detergents, alcohol, aerosol sprays or petroleum-based products.

If you need to clean the radio cover, use a cloth dampened with clean water. Do not immerse the radio in fluids.

# 13 Glossary

## A

**APCO** The Association of Public Safety Communications Officials. The APCO Project 25 standards committee (<http://www.apcointl.org/>) defined a digital radio standard. The standard is often referred to as 'APCO' or 'P25'.

## C

**channel** In a conventional system, a channel is a pair of frequencies used to transmit and receive radio signals.

In a P25 trunking system, a channel is a group of radio users.

**control channel** In a P25 trunking system, the control channel is used by the trunking site to let the radio units in the site's coverage area know when they can transmit their call information.

**conventional operation** In conventional operation, the radio is tuned to a programmed channel, and communicates with other radios either on that channel, or through a repeater system.

## **F**

**failsoft** Failsoft operation offers P25 conventional operation if the radio cannot acquire a control channel on a trunking system for an extended period of time. The conventional channel may be a repeater channel or a direct channel.

**FCC** Federal Communications Commission, an independent United States government agency that regulates interstate and international radio communications.

## **L**

**LED** Light Emitting Diode, a device that is able to emit light.

## **M**

**mute** A mute controls the circumstances under which a received signal is passed to the radio's speaker. For example, when a signal is received by the radio, the mute may remain 'closed' if the signal is not strong enough, does not have valid signaling or is encrypted.

## **P**

### **P25**

Project 25. The Association of Public Safety Communications Officials (APCO) established Project 25 (P25). This project was led by United States Federal, state, and local government representatives to develop standards for interoperable digital radios and systems to meet the needs of public safety users. See <http://www.project25.org> for further information.

### **P25 Phase 1**

P25 Phase 1 refers to radio systems operating in 12.5kHz analog, digital or mixed mode on conventional networks or in digital for trunking networks. Phase 1 digital transmissions are FDMA (Frequency Division Multiple Access) based and use Continuous 4 level Frequency Modulation (C4FM) or LSM, a linear modulation for simulcast systems.

### **P25 Phase 2**

P25 Phase 2 refers to the P25 digital Common Air Interface (CAI), Time Division Multiple Access (TDMA) based, which provides one voice channel per 6.25kHz channel spectrum efficiency. The current standards effort focuses on 2-slot TDMA which provides two voice traffic channels in a 12.5kHz allocation.

## R

### **repeater**

A repeater is a relaying site, usually situated above a city or town. The repeater extends the range of radio communications by receiving and re-transmitting signals received from radios.

### **RF**

Radio Frequency, the part of the electromagnetic spectrum that is suitable for radio transmissions. The frequency of the RF signal is described in terms of the number of cycles per second or Hertz (Hz).

### **RSSI**

Received Signal Strength Indicator, an icon or number that shows the strength of a received signal.

## T

### **traffic channel**

The traffic channel is the channel on a trunking system to which the parties participating in a call are directed to for the duration of the call. When the call ends, the traffic channel is returned to the pool of channels for use in a new call.

### **trunking operation**

In trunking operation, the trunking system manages the communications channels used by the radio, and shares a number of channels among a large number of radio users.

## V

### **valid signal**

A valid signal is a signal that the radio responds to by unmuting the receiver. A signal may be valid, for example, when it is stronger than a minimum level or has special signaling that matches the signaling programmed for the receiving radio.

# Simplified Declaration of Conformity

**EN** Hereby, Tait International Limited declares that the radio equipment type TMBB1A, TMBH5A & TMBH7A is in compliance with Directive 2014/53/EU.

The full text of the EU declaration of conformity is available at the following internet address: [www.taitradio.com/euodoc](http://www.taitradio.com/euodoc)

**BG** Съ настоящото Tait International Limited декларира, че този тип радиосъоръжение TMBB1A, TMBH5A & TMBH7A е в съответствие с Директива 2014/53/ЕС.

Цялостният текст на ЕС декларацията за съответствие може да се намери на следния интернет адрес: [www.taitradio.com/euodoc](http://www.taitradio.com/euodoc)

**ES** Por la presente, Tait International Limited declara que el tipo de equipo radioeléctrico TMBB1A, TMBH5A & TMBH7A es conforme con la Directiva 2014/53/UE.

El texto completo de la declaración UE de conformidad está disponible en la dirección Internet siguiente: [www.taitradio.com/euodoc](http://www.taitradio.com/euodoc)

**CS** Tímto Tait International Limited prohlašuje, že typ rádiového zařízení TMBB1A, TMBH5A & TMBH7A je v souladu se směrnicí 2014/53/EU.

Uplné znění EU prohlášení o shodě je k dispozici na této internetové adrese: [www.taitradio.com/euodoc](http://www.taitradio.com/euodoc)

**DA** Hermed erklærer Tait International Limited, at radioudstyrstypen TMBB1A, TMBH5A & TMBH7A er i overensstemmelse med direktiv 2014/53/EU.

EU-overensstemmelseserklæringens fulde tekst kan findes på følgende internetadresse: [www.taitradio.com/euodoc](http://www.taitradio.com/euodoc)

**DE** Hiermit erkläre Tait International Limited, dass der Funkanlagentyp TMBB1A, TMBH5A & TMBH7A der Richtlinie 2014/53/EU entspricht.

Der vollständige Text der EU-Konformitätserklärung ist unter der folgenden Internetadresse verfügbar: [www.taitradio.com/euodoc](http://www.taitradio.com/euodoc)

**ET** Käesolevaga deklareerib Tait TMBB1A, TMBH5A & TMBH7A vastab direktiivi 2014/53/EL nõuetele.

ELi vastavusdeklaratsiooni täielik tekst on kättesaadav järgmisel internetiaadressil: [www.taitradio.com/euodoc](http://www.taitradio.com/euodoc)

**EL** Με την παρούσα ο/η Tait International Limited, δηλώνει ότι ο ραδιοεξοπλισμός TMBB1A, TMBH5A & TMBH7A πληροί την οδηγία 2014/53/ΕΕ.

Το πλήρες κείμενο της δήλωσης συμμόρφωσης ΕΕ διατίθεται στην ακόλουθη ιστοσελίδα στο διαδίκτυο: [www.taitradio.com/euodoc](http://www.taitradio.com/euodoc)

**FR** Le soussigné Tait International Limited, déclare que l'équipement radioélectrique du type TMBB1A, TMBH5A & TMBH7A est conforme à la directive 2014/53/UE.

Le texte complet de la déclaration UE de conformité est disponible à l'adresse internet suivante: [www.taitradio.com/euodoc](http://www.taitradio.com/euodoc)

**HR** Tait International Limited ovime izjavljuje da je radijska oprema tipa TMBB1A, TMBH5A & TMBH7A u skladu s Direktivom 2014/53/EU.

Cjeloviti tekst EU izjave o skladnosti dostupan je na sljedećoj internetskoj adresi: [www.taitradio.com/euodoc](http://www.taitradio.com/euodoc)

**IT** Il fabbricante, Tait International Limited, dichiara che il tipo di apparecchiatura radio TMBB1A, TMBH5A & TMBH7A è conforme alla direttiva 2014/53/UE.

Il testo completo della dichiarazione di conformità UE è disponibile al seguente indirizzo Internet: [www.taitradio.com/euodoc](http://www.taitradio.com/euodoc)

**LV** Ar šo Tait International Limited deklarē, ka radioiekārta TMBB1A, TMBH5A & TMBH7A atbilst Direktīvai 2014/53/ES. Pilns ES atbilstības deklarācijas teksts ir pieejams šādā internetā vietnē: [www.taitradio.com/euodoc](http://www.taitradio.com/euodoc)

**LT** Aš, Tait International Limited, patvirtinu, kad radijo įrenginių tipas TMBB1A, TMBH5A & TMBH7A atitinka Direktyvą 2014/53/ES.

Visas ES atitikties deklaracijos tekstas prieinamas šiuo interneto adresu: [www.taitradio.com/euodoc](http://www.taitradio.com/euodoc)

**HU** Tait International Limited igazolja, hogy a TMBB1A, TMBH5A & TMBH7A típusú rádióberendezés megfelel a 2014/53/EU irányelvnek.

Az EU-megfelelőségi nyilatkozat teljes szövege elérhető a következő internetes címen: [www.taitradio.com/euodoc](http://www.taitradio.com/euodoc)

**MT** B'dan, Tait International Limited, niddikjara li dan it-tip ta' tagħmir tar-radju TMBB1A, TMBH5A & TMBH7A huwa konformi mad-Direttiva 2014/53/UE.

It-test kollu tad-dikjarazzjoni ta' konformità tal-UE huwa disponibbli f'dan l-indirizz tal-Internet li ġej: [www.taitradio.com/euodoc](http://www.taitradio.com/euodoc)

**NL** Hierbij verklaar ik, Tait International Limited, dat het type radioapparatuur TMBB1A, TMBH5A & TMBH7A conform is met Richtlijn 2014/53/EU.

De volledige tekst van de EU-conformiteitsverklaring kan worden geraadpleegd op het volgende internetadres: [www.taitradio.com/euodoc](http://www.taitradio.com/euodoc)

**PL** Tait International Limited niniejszym oświadczam, że typ urządzenia radiowego TMBB1A, TMBH5A & TMBH7A jest zgodny z dyrektywą 2014/53/UE.

Pełny tekst deklaracji zgodności UE jest dostępny pod następującym adresem internetowym: [www.taitradio.com/euodoc](http://www.taitradio.com/euodoc)

**PT** O(a) abaixo assinado(a) Tait International Limited declara que o presente tipo de equipamento de rádio TMBB1A, TMBH5A & TMBH7A está em conformidade com a Diretiva 2014/53/UE.

O texto integral da declaração de conformidade está disponível no seguinte endereço de Internet: [www.taitradio.com/euodoc](http://www.taitradio.com/euodoc)

**RO** Prin prezenta, Tait International Limited declară că tipul de echipament radio TMBB1A, TMBH5A & TMBH7A este în conformitate cu Directiva 2014/53/UE.

Textul integral al declarației UE de conformitate este disponibil la următoarea adresă internet: [www.taitradio.com/euodoc](http://www.taitradio.com/euodoc)

**SK** Tait International Limited týmto vyhlasuje, že rádiové zariadenie typu TMBB1A, TMBH5A & TMBH7A je v súlade so smernicou 2014/53/EU.

Uplné EU vyhlásenie o zhode je k dispozícii na tejto internetovej adrese:

**SL** Tait International Limited potrjuje, da je tip radijske opreme TMBB1A, TMBH5A & TMBH7A skladen z Direktivo 2014/53/EU.

Celotno besedilo izjave EU o skladnosti je na voljo na naslednjem spletnem naslovu: [www.taitradio.com/euodoc](http://www.taitradio.com/euodoc)

**FI** Tait International Limited vakuuttaa, että radiolaitetyypit TMBB1A, TMBH5A & TMBH7A on direktiivin 2014/53/EU mukainen.

EU-vaatimustenmukaisuusvakuutuksen täysimittainen teksti on saatavilla seuraavassa internetosoitteessa: [www.taitradio.com/euodoc](http://www.taitradio.com/euodoc)

**SV** Härmed försäkrar Tait International Limited att denna typ av radioutrustning TMBB1A, TMBH5A & TMBH7A överensstämmer med direktiv 2014/53/EU.

Den fullständiga texten till EU-försäkran om överensstämmelse finns på följande webbadress: [www.taitradio.com/euodoc](http://www.taitradio.com/euodoc)



# Tait Software Licence Agreement

This Software License Agreement ("Agreement") is between you ("Licensee") and Tait International Limited ("Tait").

By using any of the Software items embedded and pre-loaded in the related Tait Designated Product, included on CD, downloaded from the Tait website, or provided in any other form, you agree to be bound by the terms of this Agreement. If you do not agree to the terms of this Agreement, do not install or use any of the Software. If you install or use any of the Software, that will be deemed to be acceptance of the terms of this Agreement.

For good and valuable consideration, the parties agree as follows:

## SECTION 1 DEFINITIONS

"Confidential Information" means all or any information supplied to or received by Licensee from Tait, whether before or after installation or use and whether directly or indirectly pertaining to the Software and Documentation supplied by Tait, including without limitation all information relating to the Designated Products, hardware, software; copyright, design registrations, trademarks; operations, processes, and related business affairs of Tait; and including any other goods or property supplied by Tait to Licensee pursuant to the terms of this Agreement.

"Designated Products" means products provided by Tait to Licensee with which or for which the Software and Documentation is licensed for use.

"Documentation" means product and software documentation that specifies technical and performance features and capabilities; user, operation, and training manuals for the

Software; and all physical or electronic media upon which such information is provided.

"Executable Code" means Software in a form that can be run in a computer and typically refers to machine language, which is comprised of native instructions the computer carries out in hardware. Executable code may also refer to programs written in interpreted languages that require additional software to actually execute.

"Intellectual Property Rights" and "Intellectual Property" mean the following or their substantial equivalents or counterparts, recognized by or through action before any governmental authority in any jurisdiction throughout the world and including, but not limited to all rights in patents, patent applications, inventions, copyrights, trademarks, trade secrets, trade names, and other proprietary rights in or relating to the Software and Documentation; including any adaptations, corrections, de-compilations, disassemblies, emulations, enhancements fixes, modifications, translations and updates to or derivative works from, the Software or Documentation, whether made by Tait or another party, or any improvements that result from Tait processes or, provision of information services.

"Licensee" means any individual or entity that has accepted the terms of this License.

"Open Source Software" means software with freely obtainable source code and license for modification, or permission for free distribution.

"Open Source Software License" means the terms or conditions under which the Open Source Software is licensed.

“**Person**” means any individual, partnership, corporation, association, joint stock company, trust, joint venture, limited liability company, governmental authority, sole proprietorship, or other form of legal entity recognized by a governmental authority.

“**Security Vulnerability**” means any flaw or weakness in system security procedures, design, implementation, or internal controls that if exercised (accidentally triggered or intentionally exploited) could result in a security breach such that data is compromised, manipulated, or stolen, or a system is damaged.

“**Software**” (i) means proprietary software in executable code format, and adaptations, translations, de-compilations, disassemblies, emulations, or derivative works of such software; (ii) means any modifications, new versions and new releases of the software provided by Tait; (iii) means any upgrades, enhancements or other functions or features to the Software provided by Tait; and (iv) may contain one or more items of software owned by a third-party supplier. The term “Software” includes the applicable “Software Key” and does not include any third-party software provided under separate license or not licensable under the terms of this Agreement.

“**Source Code**” means software expressed in human readable language necessary for understanding, maintaining, modifying, correcting, and enhancing any software referred to in this Agreement and includes all states of that software prior to its compilation into an executable programme.

“**Software Key**” means a code or key that is supplied by Tait to access, enable and use the Software or certain functions or features of the Software.

“**Tait**” means Tait International Limited and includes its Affiliates.

## **Section 2 SCOPE**

This Agreement contains the terms and conditions of the license Tait is providing to Licensee, and of Licensee’s use of the Software and Documentation. Tait and Licensee enter into this Agreement in connection with Tait delivery of certain proprietary Software and/or products containing embedded or pre-loaded proprietary Software.

## **SECTION 3 GRANT OF LICENSE**

3.1. Subject to the provisions of this Agreement and the payment of applicable license fees, Tait grants to Licensee a personal, limited, non-transferable (except as permitted in Section 7), and non-exclusive license to use the Software in executable code form, and the Documentation, solely in connection with Licensee’s use of the Designated Products for the useful life of the Designated Products. This Agreement does not grant any rights to source code.

3.2. The Licensee acknowledges that one or more Software Keys may be required from Tait for the Software or certain functions or features of the Software. The Licensee may only access, enable and use such Software or functions or features of the Software with Software Keys issued by Tait. Tait may provide the Licensee with a Software Key for the Software or certain functions or features of the Software agreed to by the parties as part of this Agreement. The Software Key may control the functions or features of the Software licensed in accordance with this Agreement. The Licensee’s license to the Software Key is limited to a license to use the Software Key only to access, enable and use the Software or certain functions or features of the Software that Tait has agreed to provide to the

Licensee and only in accordance with the Documentation.

3.3. If the Software licensed under this Agreement contains or is derived from Open Source Software, the terms and conditions governing the use of such Open Source Software are in the Open Source Software Licenses of the copyright owner and not in this Agreement. If there is a conflict between the terms and conditions of this Agreement and the terms and conditions of the any applicable Open Source Software Licenses, the terms and conditions of the Open Source Software Licenses will take precedence. For information about Open Source Components contained in Tait products and the related Open Source licenses, see:

<https://www.taitradio.com/opensource>

## **SECTION 4 LIMITATIONS ON USE**

4.1. Licensee may use the Software only for Licensee's internal business purposes and only in accordance with the Documentation. Any other use of the Software is strictly prohibited. Without limiting the general nature of these restrictions, Licensee will not make the Software available for use by third parties on a "time sharing," "application service provider," "service bureau" basis, or for any other similar commercial rental or sharing arrangement.

4.2. Licensee will not, and will not directly or indirectly allow or enable any third party to: (i) reverse engineer, disassemble, extract components, decompile, reprogram, or otherwise reduce the Software or any portion thereof to a human perceptible form or otherwise attempt to recreate the source code; (ii) modify, adapt, create derivative works of, or merge the Software; (iii) copy, reproduce, distribute, lend, or lease the Software or Documentation to any third party;

(iv) grant any sublicense or other rights in the Software or Documentation to any third party; (v) take any action that would cause the Software or Documentation to be placed in the public domain; (vi) remove, or in any way alter or obscure any copyright notice or other notice of Tait or third-party licensor's proprietary rights; (vii) provide, copy, transmit, disclose, divulge or make the Software or Documentation available to, or permit the use of the Software by, any third party or on any machine except as expressly authorized by this Agreement; or (viii) use, or permit the use of, the Software in a manner that would result in the production of a copy of the Software by any means whatsoever other than what is permitted in this Agreement. Licensee may make one copy of the Software to be used solely for archival, back-up, or disaster recovery purposes; provided that Licensee may not operate that copy of the Software at the same time as the original Software is being operated. Licensee may make as many copies of the Documentation as it may reasonably require for the internal use of the Software.

4.3. Unless otherwise authorized by Tait in writing, Licensee will not, and will not enable or allow any third party to: (i) install a copy of the Software on more than one unit of a Designated Product; or (ii) copy or transfer Software installed on one unit of a Designated Product to any other device. Licensee may temporarily transfer Software installed on a Designated Product to another device if the Designated Product is inoperable or malfunctioning. Temporary transfer of the Software to another device must be discontinued when the original Designated Product is returned to operation and the Software must be removed from the other device.

4.4. Licensee will maintain, during the term of this Agreement and for a

period of two years thereafter, accurate records relating to this license grant to verify compliance with this Agreement. Tait, or a third party nominated by Tait, may inspect Licensee's premises, books and records, upon reasonable prior notice to Licensee, during Licensee's normal business hours and subject to Licensee's facility and security regulations. Tait is responsible for the payment of all expenses and costs of the inspection, provided that Licensee shall indemnify Tait for all costs (including audit costs and legal costs on a solicitor client basis) if Licensee has breached the terms of this Agreement. Any information obtained by Tait during the course of the inspection will be kept in strict confidence by Tait and used solely for the purpose of verifying Licensee's compliance with the terms of this Agreement.

## **SECTION 5 OWNERSHIP AND TITLE**

Tait, its licensors, and its suppliers retain all of their Intellectual Property Rights in and to the Software and Documentation, in any form. No rights are granted to Licensee under this Agreement by implication, estoppel or otherwise, except for those rights which are expressly granted to Licensee in this Agreement. All Intellectual Property developed, originated, or prepared by Tait in connection with providing the Software, Designated Products, Documentation, or related services, remains vested exclusively in Tait, and Licensee will not have any shared development or other Intellectual Property Rights.

## **SECTION 6 LIMITED WARRANTY; DISCLAIMER OF WARRANTY**

6.1. The commencement date and the term of the Software warranty will be a

period of one (1) year from Tait shipment of the Software. If Licensee is not in breach of any obligations under this Agreement, Tait warrants that the unmodified Software, when used properly and in accordance with the Documentation and this Agreement, will be free from a reproducible defect that eliminates the functionality or successful operation of a feature critical to the primary functionality or successful operation of the Software. Whether a defect has occurred will be determined solely by Tait. Tait does not warrant that Licensee's use of the Software or the Designated Products will be uninterrupted, error-free, completely free of Security Vulnerabilities, or that the Software or the Designated Products will meet Licensee's particular requirements. Tait makes no representations or warranties with respect to any third-party software included in the Software.

6.2 Tait sole obligation to Licensee, and Licensee's exclusive remedy under this warranty, is to use reasonable efforts to remedy any material Software defect covered by this warranty. These efforts will involve either replacing the media or attempting to correct significant, demonstrable program or documentation errors or Security Vulnerabilities. If Tait cannot correct the defect within a reasonable time, then at Tait option, Tait will replace the defective Software with functionally equivalent Software, license to Licensee substitute Software which will accomplish the same objective, or terminate the license and refund Licensee's paid license fee. If Tait investigation of the perceived defect reveals that no such defect in fact exists, Tait may recover its costs in respect of such investigation from Licensee.

6.3. Tait disclaims any and all other warranties relating to the Software or

Documentation other than the express warranties set forth in this Section 6. Warranties in Section 6 are in lieu of all other warranties whether express or implied, oral or written, and including without limitation any and all implied warranties of condition, title, non-infringement, merchantability, or fitness for a particular purpose or use by Licensee (whether Tait knows, has reason to know, has been advised of, or is otherwise aware of any such purpose or use), whether arising by law, by reason of custom or usage of trade, or by course of dealing. In addition, Tait disclaims any warranty to any person other than Licensee with respect to the Software or Documentation.

## **SECTION 7 TRANSFERS**

7.1. Licensee will not transfer the Software or Documentation to any third party without specific prior written consent from Tait. Tait may withhold such consent or at its own discretion make the consent conditional upon the transferee paying applicable license fees and agreeing to be bound by this Agreement.

7.2. In the case of a value-added reseller or distributor of Tait Designated Products, the consent referred to in Section 7.1 may be contained in a Tait Reseller or Tait Distributor Agreement.

7.3. If the Designated Products are Tait vehicle-mounted mobile products or hand-carried portable radio products and Licensee transfers ownership of the Tait mobile or portable radio products to a third party, Licensee may assign its right to use the Software which is embedded in or furnished for use with the radio products and the related Documentation; provided that Licensee transfers all copies of the Software and Documentation to the transferee.

7.4. 7.4. For the avoidance of any doubt, Section 7.3 excludes TaitNet Infrastructure, or the products listed at any time under network products at: <http://www.taitradio.com>.

7.5. If Licensee, as a contractor or subcontractor (integrator), is purchasing Tait Designated Products and licensing Software not for its own internal use but for end use only by a Customer, the Licensee may transfer such Software, but only if a) Licensee transfers all copies of such Software and the related Documentation to the transferee and b) Licensee has first obtained from its Customer (and, if Licensee is acting as a subcontractor, from the interim transferee(s) and from the ultimate end user sub license) an enforceable sublicense agreement that prohibits any other transfer and that contains restrictions substantially identical to the terms set forth in this Software License Agreement. Except as stated in the foregoing, Licensee and any transferee(s) authorised by this Section may not otherwise transfer or make available any Tait Software to any third party nor permit any party to do so. Licensee will, on request, make available evidence reasonably satisfactory to Tait demonstrating compliance with all the foregoing.

## **SECTION 8 TERM AND TERMINATION**

8.1. Licensee's right to use the Software and Documentation will commence when the Designated Products are supplied by Tait to Licensee and will continue for the life of the Designated Products with which or for which the Software and Documentation are supplied, unless Licensee breaches this Agreement, in which case this Agreement and Licensee's right to use the Software and Documentation may be terminated immediately upon notice by Tait.

8.2. Within thirty (30) days after termination of this Agreement, Licensee must certify in writing to Tait that all copies of the Software have been removed or deleted from the Designated Products and that all copies of the Software and Documentation have been returned to Tait or destroyed by Licensee and are no longer in use by Licensee.

8.3. Licensee acknowledges that Tait made a considerable investment of resources in the development, marketing, and distribution of the Software and Documentation and that Licensee's breach of this Agreement will result in irreparable harm to Tait for which monetary damages would be inadequate. If Licensee breaches this Agreement, Tait may terminate this Agreement and be entitled to all available remedies at law or in equity including immediate injunctive relief and repossession of all non-embedded Software and associated Documentation. Licensee shall pay all Tait costs (on an indemnity basis) for the enforcement of the terms of this Agreement.

## **SECTION 9 CONFIDENTIALITY**

Licensee acknowledges that the Software and Documentation contain proprietary and Confidential Information valuable to Tait and are Tait trade secrets, and Licensee agrees to respect the confidentiality of the information contained in the Software and Documentation.

## **SECTION 10 LIMITATION OF LIABILITY**

10.1. In no circumstances shall Tait be under any liability to Licensee, or any other person whatsoever, whether in Tort (including negligence), Contract (except as expressly provided in this Agreement), Equity, under any Statute, or otherwise at law for any losses or damages whether general, special, exemplary, punitive, direct,

indirect, or consequential arising out of or in connection with any use or inability of using the Software.

10.2. Licensee's sole remedy against Tait will be limited to breach of contract and Tait sole and total liability for any such claim shall be limited at the option of Tait to the repair or replacement of the Software or the refund of the purchase price of the Software.

## **SECTION 11 GENERAL**

11.1. COPYRIGHT NOTICES. The existence of a copyright notice on the Software will not be construed as an admission or presumption of publication of the Software or public disclosure of any trade secrets associated with the Software.

11.2. COMPLIANCE WITH LAWS. Licensee acknowledges that the Software may be subject to the laws and regulations of the jurisdiction covering the supply of the Designated Products and will comply with all applicable laws and regulations, including export laws and regulations, of that country.

11.3. ASSIGNMENTS AND SUBCONTRACTING. Tait may assign its rights or subcontract its obligations under this Agreement, or encumber or sell its rights in any Software, without prior notice to, or consent of, Licensee.

11.4. GOVERNING LAW. This Agreement shall be subject to and construed in accordance with New Zealand law and disputes between the parties concerning the provisions hereof shall be determined by the New Zealand Courts of Law. Provided however Tait may at its election bring proceedings for breach of the terms hereof or for the enforcement of any judgment in relation to a breach of the terms hereof in any jurisdiction Tait considers fit for the purpose of ensuring compliance with the terms hereof or obtaining relief for breach of the terms hereof.

#### 11.5. THIRD-PARTY

**BENEFICIARIES.** This Agreement is entered into solely for the benefit of Tait and Licensee. No third party has the right to make any claim or assert any right under this Agreement, and no third party is deemed a beneficiary of this Agreement. Notwithstanding the foregoing, any licensor or supplier of third-party software included in the Software will be a direct and intended third-party beneficiary of this Agreement.

**11.6. SURVIVAL.** Sections 4, 5, 6.3, 7, 8, 9, 10, and 11 survive the termination of this Agreement.

**11.7. ORDER OF PRECEDENCE.** In the event of inconsistencies between this Agreement and any other Agreement between the parties, the parties agree that, with respect to the specific subject matter of this Agreement, this Agreement prevails.

**11.8 SECURITY.** Tait uses reasonable means in the design and writing of its own Software and the acquisition of third-party Software in order to limit Security Vulnerabilities. While no software can be guaranteed to be free from Security Vulnerabilities, if a Security Vulnerability is discovered, Tait will take the steps specified in Section 6 of this Agreement.

**11.9 EXPORT.** Licensee will not transfer, directly or indirectly, any Designated Product, Documentation or Software furnished hereunder or the direct product of such Documentation or Software to any country for which New Zealand or any other applicable country requires an export license or other governmental approval without first obtaining such license or approval.

**11.10 SEVERABILITY.** In the event that any part or parts of this Agreement shall be held illegal or null and void by any court or administrative body of competent jurisdiction, such determination shall not affect the

remaining terms which shall remain in full force and effect as if such part or parts held to be illegal or void had not been included in this Agreement. Tait may replace the invalid or unenforceable provision with a valid and enforceable provision that achieves the original intent and economic effect of this Agreement.

**11.11 CONSUMER GUARANTEES.** Licensee acknowledges that the licenses supplied in terms of this agreement are supplied to Licensee in business, and that the guarantees and other provisions of prevailing consumer protection legislation shall not apply.

**11.12 WHOLE AGREEMENT.** Licensee acknowledges that it has read this Agreement, understands it and agrees to be bound by its terms and conditions. Licensee also agrees that, subject only to the express terms of any other agreement between Tait and Licensee to the contrary, this is the complete and exclusive statement of the Agreement between it and Tait in relation to the Software. This Agreement supersedes any proposal or prior agreement, oral or written, and any other communications between Licensee and Tait relating to the Software and the Designated Products.







