

TM9300 DMR Mobile Radios User's Guide

MMB-00001-11 · Issue 11 · August 2020



Contents

For your safety	8
Menu maps	17
1 About this guide	19
Safety warnings used in this guide	19
Related documentation.....	20
2 Getting started	21
About your DMR digital radio.....	22
About the radio controls.....	24
Understanding the radio display	27
Understanding the radio indicators.....	29
Using function keys to access frequently used features.....	32
Navigating the radio's menus	33
Using the alphanumeric keys to search a list	34
3 Basic operation	35
Turning the radio on and off	36
Adjusting the speaker volume	37
Locking and unlocking the keypad	38
Changing the radio's operating mode.....	39
Setting and viewing the radio's time and date	40
4 Using the address book	41
Opening the address book	42
Changing the default address book.....	42
Navigating the address book.....	43
Filtering address book lists	44
Maintaining personal address book entries	45
5 Operating in conventional mode	49
Selecting a zone	50
Selecting a channel	51
Selecting a scan or voting group	52
Understanding talkgroups.....	54
Making a call.....	55
Making an individual call.....	57
Making a preset call.....	57
Making a call using the address book	58
Making a local call	59
Dialing a radio call	59
Making a phone call.....	60
Making a DTMF patch call.....	61
Making an emergency call.....	63

Setting your status (on analog channels)	63
Sending and receiving status messages	64
Sending and receiving text messages	65
Checking the queue.....	69
Call alert	70
Radio check.....	72
Radio monitor	73
Radio inhibit and uninhibit	74
Resending calls automatically	76
Transmitting at low power.....	77
Ending active calls.....	78
Using monitor and squelch override (on analog channels)	79
Bypassing the repeater (on analog channels)	80
Receiving a call	81
Using the radio in different repeater areas	82
Scanning a group of channels	83
6 Operating in trunked mode	89
Checking that your network is available	90
Changing your network.....	90
Making a call using the address book	91
Making a preset call.....	92
About trunked zones and workgroups	93
About emergency operation	97
Dialing a PABX number.....	99
Dialing a PSTN number	99
Receiving a call	100
Re-establishing a call	102
Checking the queue.....	103
About status messages	106
About trunked text messages	108
Placing the radio in do-not-disturb mode.....	111
Switching to conventional channels or conventional groups ..	112
7 Dialing calls in trunked mode	113
MPT 1343 dialing.....	114
DMR dialing	116
Nokia ANN fleet calls.....	118
Accessing common trunking functions	120
8 Location services	123
About location information	124
About location statuses	124
Viewing location information.....	125
9 Loneworker monitoring	126
Activating loneworker monitoring.....	126

Responding to a loneworker alarm.....	127
10 Encryption	128
About encryption.....	129
Encrypting calls	129
Making an encrypted call.....	130
Receiving an encrypted call.....	130
Removing encryption keys from the radio	131
11 Customizing radio settings	132
Changing the volume of all audible indicators	133
Changing the volume of keypress tones	133
Changing to quiet operation	134
Changing to silent operation.....	134
Changing the external alert option.....	135
Turning on backlighting	135
Adjusting the display contrast.....	137
12 Troubleshooting	138
When the radio won't turn on.....	139
Identifying the radio's audible tones	139
Viewing radio information	139
Removing the microphone.....	140
General care.....	141
Simplified Declaration of Conformity	142
Tait Software License Agreement.....	143

Copyright and trademarks

All information contained in this document is the property of Tait International Limited. All rights reserved. This document may not, in whole or in part, be copied, photocopied, reproduced, translated, stored, or reduced to any electronic medium or machine-readable form, without prior written permission from Tait International Limited.

The word TAIT and the TAIT logo are trademarks of Tait International Limited.

All trade names referenced are the service mark, trademark or registered trademark of the respective manufacturers.

Disclaimer

There are no warranties extended or granted by this document. Tait International Limited accepts no responsibility for damage arising from use of the information contained in the document or of the equipment and software it describes. It is the responsibility of the user to ensure that use of such information, equipment and software complies with the laws, rules and regulations of the applicable jurisdictions.

Enquiries and comments

If you have any enquiries regarding this document, or any comments, suggestions and notifications of errors, please contact your regional Tait office.

Updates of manual and equipment

In the interests of improving the performance, reliability or servicing of the equipment, Tait International Limited reserves the right to update the equipment or this document or both without prior notice.

Intellectual property rights

This product may also be made under license under one or more of the following patents:

- US7203207, AU2004246135, CA2527142, GB2418107, HK1082608, MY134526, US8306071

- US7339917, AU2004246136, CA2526926, GB2418812, MY134217

- US7499441, AU2005262626, CA2570441, GB2430333, JP4690397, NZ551231, KR100869043, RU2351080, BRP10512052, MXPA06015241

- US 7200129, AU2005226531, CA2558551, CN1930809, GB2429378, JP4351720, BRP10508671, NZ549124, KR848483, RU2321952

Environmental responsibilities

Tait International Limited is an environmentally responsible company which supports waste minimization, material recovery and restrictions in the use of hazardous materials.

The European Union's Waste Electrical and Electronic Equipment (WEEE) Directive requires that this product be disposed of separately from the general waste stream when its service life is over. For more information about how to dispose of your unwanted Tait product, visit the Tait WEEE website at www.taitradio.com/weee. Please be environmentally responsible and dispose through the original supplier, or contact Tait International Limited.

Tait International Limited also complies with the Restriction of the Use of Certain Hazardous Substances in Electrical and Electronic Equipment (RoHS) Directive in the European Union.

In China, we comply with the Measures for Administration of the Pollution Control of Electronic Information Products. We will comply with environmental requirements in other markets as they are introduced.

For your safety

Before using your radio, please read the following important safety and compliance information.

Radio frequency exposure information



For your own safety and to ensure you comply with the radio frequency (RF) exposure guidelines of the United States Federal Communication Commission's (FCC), Industry Canada, and those from other administrations, please read the following information before using this radio.

Using this radio

You should use this radio only for work-related purposes (it is not authorized for any other use) and if you are fully aware of, and can exercise control over, your exposure to RF energy. To prevent exceeding FCC RF exposure limits, you must control the amount and duration of RF that you and other people are exposed to.

It is also important that you:

- Do not remove the RF Exposure label from the radio.
- Ensure this RF exposure information accompanies the radio when it is transferred to other users.
- Do not use the radio if you do not adhere to the guidelines on controlling your exposure to RF.

Controlling your exposure to RF energy



Warning RF exposure hazard!

To comply with FCC and Industry Canada RF exposure limits, mount the antenna at a location such that no person or persons can come closer than 35 inches (0.9m) to the antenna:

For radios with a transmit power >25W:

VHF radios must be installed using an antenna with a gain

of up to 5.15dBi.

UHF and 800MHz radios must be installed using an antenna with a gain of up to 5.65dBi.

900MHz radios must be installed using an antenna with a gain of up to 8dBi.

For radios with a transmit power of 25W:

The radio must be installed using an externally mounted antenna with a gain of up to 5.15dBi.

This radio emits radio frequency (RF) energy or radio waves primarily when calls are made. RF is a form of electromagnetic energy (as is sunlight), and there are recommended levels of maximum RF exposure.

To control your exposure to RF and comply with the maximum exposure limits for occupational/controlled environments, follow these guidelines:

- Do not talk (transmit) on the radio more than the rated transmit duty cycle. This is important because the radio radiates more energy when it is transmitting than when it is receiving.
- While you are transmitting (talking or sending data) on the radio, you must ensure that there is always a distance of 35 inches (0.9m) between people and the antenna. This is the minimum safe distance.
- Use the radio only with Tait-approved antennas and attachments, and make only authorized modifications to the antenna otherwise you could damage the radio and violate FCC regulations.

For more information on what RF energy is and how to control your exposure to it, visit the FCC website at www.fcc.gov/oet/rfsafety/rf-faqs.html.

Health Canada warning statement

The installer of this radio equipment must ensure that the antenna is located or pointed such that it does not emit an RF field in excess of Health Canada limits for the general population; consult Safety Code 6, obtainable from the Health Canada's website <http://www.hc-sc.gc.ca>.

Compliance with RF energy exposure standards

This two-way radio complies with these RF energy exposure standards and guidelines:

- United States Federal Communications Commission, Code of Federal Regulations; 47 CFR §§ 1.1307, 1.1310, and 2.1091.
- American National Standards Institute (ANSI) / Institute of Electrical and Electronic Engineers (IEEE) C95.1-1992.
- Institute of Electrical and Electronic Engineers (IEEE) C95.1-1999 Edition.
- European Directive 2004/40/EC on minimum health and safety requirements regarding the exposure of workers to the risks arising from physical agents (electromagnetic fields).

This radio complies with the IEEE and ICNIRP exposure limits for occupational/controlled RF exposure environments at operating duty factors of up to 50% talk to 50% listen.

Conformité aux normes d'exposition à l'énergie RF

Cette radio émetteur-récepteur se conforme aux normes et aux règlements d'exposition à l'énergie RF :

- La Commission fédérale de la communication des Etats-Unis, Code de règlements fédéraux (CFR) Titre 47 Sections 1.1307, 1.1310 et 2.1091 (radios mobiles) ou 2.1093 (radios portatives).
- American National Standards Institute (ANSI) / Institute of Electrical and Electronic Engineers (IEEE) C95. 1-1992.
- Institute of Electrical and Electronic Engineers (IEEE) C95.1-1999 Edition.
- La directive européenne 2004/40/EC concernant les prescriptions minimales de sécurité et de santé relatives à l'exposition des travailleurs aux risques dus aux agents physiques (champs électromagnétiques).

Cette radio se conforme aux limites d'exposition de l'IEEE (FCC) et ICNIRP pour les environnements d'exposition au rayonnement RF professionnel et contrôlé aux cycles de marche de 50% en mode transmission et 50% en mode réception.

Radio frequency emissions limits in the USA

Part 15 of the FCC Rules imposes RF emission limits on receivers. This radio complies with Part 15 of the FCC Rules. Operation is subject to the condition that this device does not cause harmful interference.

Radio frequency emissions limits in Canada

This device complies with Industry Canada licence exempt RSS standard(s). Operation is subject to the following two conditions: (1) this device may not cause interference, and (2) this device must accept any interference, including interference that may cause undesired operation of the device.

Le présent appareil est conforme aux CNR d'Industrie Canada applicables aux appareils radio exempts de licence. L'exploitation est autorisée aux deux conditions suivantes : (1) l'appareil ne doit pas produire de brouillage, et (2) l'utilisateur de l'appareil doit accepter tout brouillage radioélectrique subi, même si le brouillage est susceptible d'en compromettre le fonctionnement.

USA public safety bands (764–776MHz and 794–806MHz)

The Code of Federal Regulations (CFR) Title 47 Subpart R deals with the use of frequencies in the 764 to 776MHz and 794 to 806MHz bands.

Low-power channels

This radio complies with §90.531 (b) (3) and §90.531 (b) (4) of 47 CFR. These sections state that only low-power transmission is permitted on the following channels:

- Regional Planning channels, as defined in §90.531 (b) (3).
- Itinerant channels, as defined in §90.531 (b) (4).

Use of encryption

This radio complies with §90.553 (a) of 47 CFR. This states that:

- Encryption is not permitted on the nationwide Interoperability calling channels. These channels are defined in §90.531 (b) (1) (ii).
- Radios using encryption must have a readily accessible switch or control to allow the radio user to disable encryption.

EMC regulatory compliance in Australia



This product meets all ACMA regulatory requirements for electromagnetic compatibility (EMC). For more information about EMC compliance, visit the ACMA website at www.acma.gov.au.

Frequency band reserved for distress beacons

Frequency band 406 to 406.1 MHz is reserved for use by distress beacons. Transmissions should not be made within this frequency band.

Health, safety and electromagnetic compatibility in Europe

In the European Community, radio and telecommunications equipment is regulated by Directive 2014/3/EU. The requirements of this directive include protection of health and safety of users, as well as electromagnetic compatibility.

Intended purpose of product

This product is an FM radio transceiver. It is intended for radiocommunication in the Private Mobile Radio (PMR) or Public Access Mobile Radio (PAMR) services, to be used in all member states of the European Union (EU) and states within the European Economic Area (EEA).

Restrictions

This product can be programmed to transmit on frequencies that are not harmonized throughout the EU/EEA, and will require a licence to operate in each member state.

This product can be programmed for frequencies or emissions that may make its use illegal. Where applicable, a license must be obtained before this product is used. All license requirements must be observed. Limitations may apply to transmitter power, operating frequency, channel spacing, and emission.

Declaration of conformity

Brief Declarations of Conformity appear on [page 142](#) of this booklet. To download the formal declaration of conformity, go to www.taitradio.com/eudoc.

Interference with electronic devices



Warning Some electronic devices may be prone to malfunction due to the lack of protection from RF energy that is present when your radio is transmitting.

Examples of electronic devices that may be affected by RF energy are:

- aircraft electronic systems

- vehicular electronic systems such as fuel injection, anti-skid brakes, and cruise control
- medical devices such as pacemakers and hearing aids
- medical equipment in hospitals or health care facilities.

Switch off the radio before boarding an aircraft. Using your radio while in the air is not permitted.

Consult the manufacturer (or its representative) of any such electronic devices to determine whether electronic circuits in those devices will perform normally when the radio is transmitting.



Warning If you have a pacemaker, immediately turn off the radio if you suspect it is interfering with the pacemaker.

If there is interference between your hearing aid and the radio, please discuss an alternative solution with the hearing aid manufacturer.

Potentially explosive atmospheres and blasting areas



Warning Unless the radio is specifically certified for use in a potentially explosive atmosphere, turn off the radio before entering such an atmosphere. An explosion could cause serious injury or death. Examples of potentially explosive atmospheres include filling stations, and any environment where there are flammable liquids, gases, or dusts.



Warning Turn off the radio before approaching blasting caps, a blasting area, or any area where you are instructed to turn off a two-way radio. Obey all signs and instructions. Interference with blasting operations could cause serious injury or death.

Radio installation and operation in vehicles



Warning Keep the radio away from airbags and airbag deployment areas. Do not install, charge, or place a radio near such areas. An activated airbag can propel a portable radio with sufficient force to cause serious injury to vehicle occupants. An airbag may not perform to specification if obstructed by a radio.



Warning To avoid damage to existing wiring, airbags, fuel tanks, fuel and brake lines, or battery cables, refer to the installation guide for the radio, and to the vehicle manufacturer's manual, before installing electronic equipment in the vehicle.

Using a handheld microphone or a radio while driving a vehicle may violate the laws and legislation that apply in your country or state. Please check the vehicle regulations in your area.

Radio protection when charging the vehicle battery

Always remove the fuses from the radio power cable before charging the vehicle battery, connecting a second battery, or using power from another vehicle (e.g. when jump-starting the vehicle).

Electromagnetic compatibility in European vehicles

In the European Community, radio equipment fitted to automotive vehicles is regulated by Directive 72/245/EEC and its amendments. The requirements of this directive cover the electromagnetic compatibility of electrical or electronic equipment fitted to automotive vehicles.

To meet the requirements of Directive 72/245/EEC and its amendments, installation of this product in a vehicle must be performed according to the instructions provided by the vehicle manufacturer

Notice Failure to install the product correctly may void the vehicle's type-approval. The owner could be held responsible for any damage resulting from vehicle failure that can be attributed to RF energy interfering with the vehicle systems.

Unapproved modifications or changes to radio

The radio is designed to satisfy the applicable compliance regulations. Do not make modifications or changes to the radio that are not expressly approved by Tait. Failure to do so could invalidate compliance requirements and void the user's authority to operate the radio.

High radio surface temperatures



Caution The bottom surface of the radio and the heatsink fins can become hot during prolonged operation. Do not touch these parts of the radio.

EN 60950 requirements (25 watt mobiles)

This radio complies with the European Union standard EN 60950 when operated up to the rated 33% duty cycle of two minutes transmit and four minutes receive, and with ambient temperatures of 30°C or lower.



Caution Operation outside these limits may cause the external temperature of the radio to rise higher than this standard permits.

Menu maps

This section shows the menus and submenus that may be programmed for your radio. Some features are controlled by software licenses and may not be available with your model.

Main menu (conventional mode)

Call queue

Channels

Zones

Address book

Personal

Standard

Individual call

Phone call

Local calls

Set status

Dial radio call

Dial patch call

Services

Text message

Status update

Call alert

Radio check

Radio monitor

Radio inhibit

Radio uninhibit

Talkgroups

Radio settings

Functions

Scrambler

Lock radio

Low power tx

Monitor

Squelch o'ride

VOX

VOX sensitivity

Repeater

Talkaround

External PA

Voice annunciation

Call settings

Ignore 2-tone

Extra features

Lone worker

Alert settings

External alert

Indicator level

Keypress tones

Quiet operation

Silent operation

Display settings

Backlight level

Backlighting

Contrast adjust

Talk party ID

RSSI

Radio info

Radio ID

Key settings

Multi head info

Version info

Customer info

Serial number

Advanced

Program groups

Location Svs

Own location

Security

Encryption

Zeroize key

Zeroize all

Change mode

Diagnostics

Time and Date

Unify Apps

Main menu (trunked mode)

- Call queue**
- Preset calls**
- Address book**
 - Personal
 - Standard
- Set zone**
- Set workgroup**
- Go to homegroup**
- Scanning**
- Send**
 - Status
 - Text message
 - Dispatcher call
 - Broadcast call
 - Conference call
 - Priority call
 - Emergency call
- Workgroup setup***
 - My Workgroups**
 - Set homegroup
 - Subscribe all
 - Unsubscribe all

Radio settings

- Functions
 - Scrambler
 - Lock radio
 - VOX
 - VOX sensitivity
 - External PA
 - Voice annunciation
- Call settings
 - Call queuing
 - Do not disturb
- Extra features
 - Lone worker
- Alert settings
 - External alert
 - Indicator level
 - Keypress tones
 - Quiet operation
 - Silent operation
- Display settings
 - Backlight level
 - Backlighting
 - Contrast adjust
 - Channel display
 - RSSI
- Radio info
 - Trunked ID
 - Key settings
 - Multi head info
 - Version info
 - Customer info
 - Serial number
 - Alias

Call groups

Own location

Security

- Encryption
- Zeroize key
- Zeroize all

Change network

Change mode

Diagnostics

Time and Date

Unify Apps

* This menu item may appear as 'Group select'

** This menu item may appear as 'Edit groups'.

1 About this guide

This user's guide provides information about all TM9300 mobile radios except the TM9315 (with 2-digit display).

The radio behavior described in this guide applies to radios with firmware version 2.18. To check the radio's firmware version, see "[Viewing radio information](#)" on page 139. If your radio does not operate as you expect, contact your radio provider for assistance.

Safety warnings used in this guide

Please follow exactly any instruction that appears in the text as an 'alert'. An alert provides necessary safety information as well as instruction in the proper use of the product. This user's guide uses the following types of alert:



Warning This alert is used when there is a hazardous situation which, if not avoided, could result in death or serious injury.



Caution This alert is used when there is a hazardous situation which, if not avoided, could result in minor or moderate injury.

Notice This alert is used to highlight information that is required to ensure procedures are performed correctly. Incorrectly performed procedures could result in equipment damage or malfunction.



This icon is used to draw your attention to information that may improve your understanding of the equipment or procedure.

Related documentation

The following documentation is also available for your Tait radio, which you can access from the Tait Technical Support website (<http://support.taitradio.com>):

- *Safety and Compliance Information*—supplied with each radio. (The same information is included in this user's guide.)
- *Installation Guide*—covers installing TM9300 mobile radios, microphones, antennas, emergency switches, and external alert devices.
- *Accessory installation instructions*—may be supplied with an accessory.

2 Getting started

This section gives an overview of your DMR radio, describes the radio's controls and indicators, and explains how the radio menus are organized.

This section covers:

- [About your DMR digital radio](#)
- [About the radio controls](#)
- [Understanding the radio display](#)
- [Understanding the radio indicators](#)
- [Using function keys to access frequently used features](#)
- [Navigating the radio's menus](#)
- [Using the alphanumeric keys to search a list](#)

About your DMR digital radio

Your DMR digital radio can be programmed for DMR conventional or DMR trunked operation. Analog conventional and MPT operation is also available.

 DMR and MPT trunking operation is controlled by a software license (SFE) and may not be available with your radio.

In DMR and MPT trunking operation, dual-mode networks are able to receive both digital and analog calls.

You may notice differences between digital and analog calls in terms of:

- static noise in low signal areas, and
- radio coverage in marginal reception areas.

Lack of static noise

On digital networks there is no static noise, even in low signal areas. This lack of static is because your digital radio removes the 'noise' from the call, so that you hear only clear voice.

Coverage

With digital networks, a call remains clear and then drops off quickly at the border of a coverage area. The reason for this is that a digital call is either received or it isn't. With analog networks, the background noise in a call gets progressively worse when you are in fringe areas or even slightly outside normal coverage areas.

What you hear on an analog channel

On analog channels, your radio may be programmed so that you hear all conversations on a channel, or your user group may be segregated from other user groups by using special signaling. The special signaling is used to control the muting and unmuting of your radio, so that your radio is muted when other user groups are talking and unmuted for members of your user group.

There are two muting controls that operate in your radio:

- signaling mute
- squelch

Signaling mute

The radio's signaling mute only allows the radio to unmute if the incoming call carries the tones specific to your user group. Your user group may use tones that are either audible, subaudible or both.

Squelch

The radio's squelch allows the radio to unmute only when the strength of the incoming signal is above a predetermined threshold. This means that only signals of reasonable intelligibility are made audible.

About the radio controls

The radio controls are the PTT key, volume control, on/off key, scroll keys, selection keys and function keys. Some keys have functions assigned to both short and long key presses:

- a short key press is less than one second, and
- a long key press is more than one second.

The radio controls and their functions are described in the following sections.

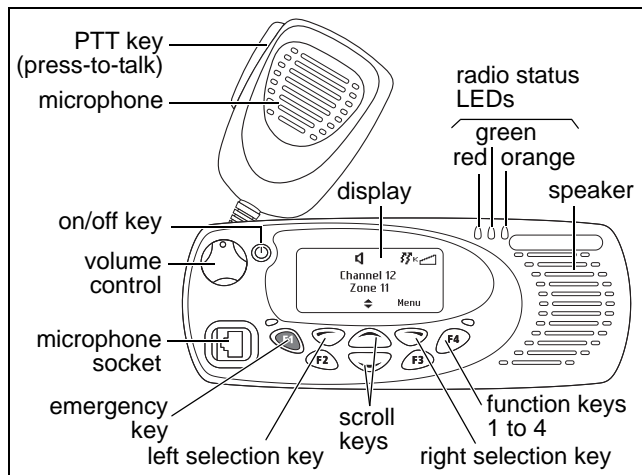

Name	Function
PTT key	Press and hold to transmit and release to listen
Volume control	Rotate to change the speaker volume
On/off key	Turn the radio on or off with a long press
Left and right selection keys	Action determined by the text above the selection key
Scroll keys	Scroll up and down through a list of menu options, scroll left and right in messages, or access a pre-programmed menu
Emergency key	Activates emergency mode
Function keys	Programmed for frequently used options

About the keypad microphone

Your radio may have a keypad microphone installed. The keypad microphone has a PTT key as well as alphanumeric keys, two scroll keys, and left and right selection keys.

The PTT key, the scroll keys and the selection keys all work in the same way as those on the radio control head (see ["About the radio controls"](#)).

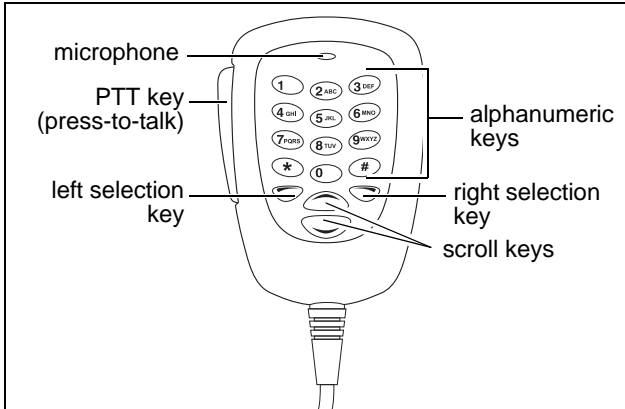

About the hand-held control head

Your radio may have a hand-held control head installed, to enable you to operate the radio at a distance from the radio body.

The keys and controls work in the same way as those on the standard control head, with the exception of the PTT and volume up and down keys. The hand-held control head also has two additional function keys.

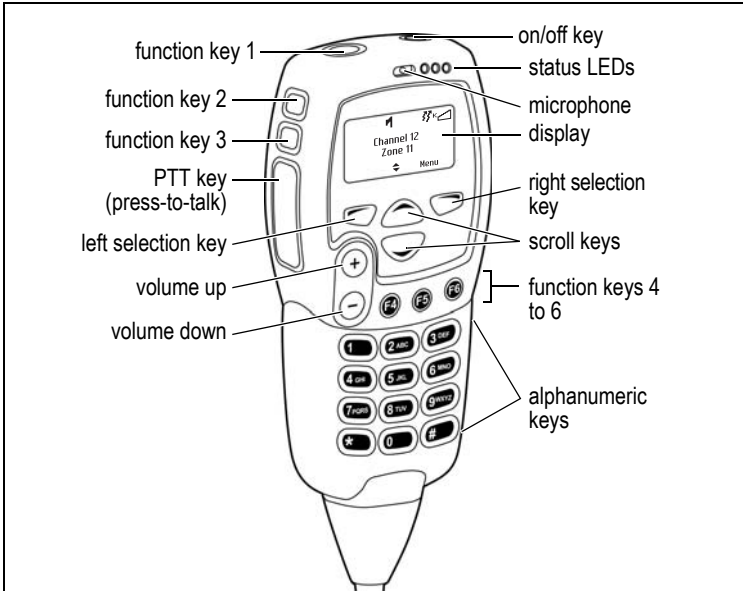





















Understanding the radio display

The messages and icons you see on your radio display depend on the mode in which your radio is operating and the way it is programmed.

Radio display icons

These are some of the icons you may see on your radio display:

Icon	Meaning
	Scanning: your radio is monitoring a group of channels or workgroups for activity
	External alert: external alert is turned on
	Silent operation: your radio's audible tones have been turned off
	Low-power transmit: your radio is set to transmit on low power
	Transmit: your radio is transmitting
	Manual mode: automatic channel or zone selection has been turned off
	Scrambler: the voice-inversion scrambler is turned on (analog channels only)
	Signal strength indicator: the more bars, the stronger the signal being received by the radio
	Scrolling: you can use  or  to move through a list, or access a pre-programmed menu
	Queuing: there are calls or messages in the queue

Icon	Meaning
Trunked mode icons	
	Scanning: scanning has been turned off
	Homegroup: your radio has been returned to the homegroup using the homegroup toggle function key
	Network: your radio is registered on a trunked network Flashing: your radio is attempting to register on a trunked network
	'Full' queuing activated: all calls and messages are sent directly to the queue (see page 104)
	Trunking: your radio has established a call and you are now able to speak to the other party
Conventional mode icons	
	Monitor or squelch override: monitor or squelch override is turned on
	Scanning: your radio is monitoring a group of channels for activity, and the currently selected channel is a member of the scan group.
	Repeater talkaround: your radio is operating in repeater talkaround mode, or you are on a simplex channel
	Zone: this letter represents the zone in which your radio is operating, where A is zone 1, Z is zone 26 (for example, K represents zone 11)

Understanding the radio indicators





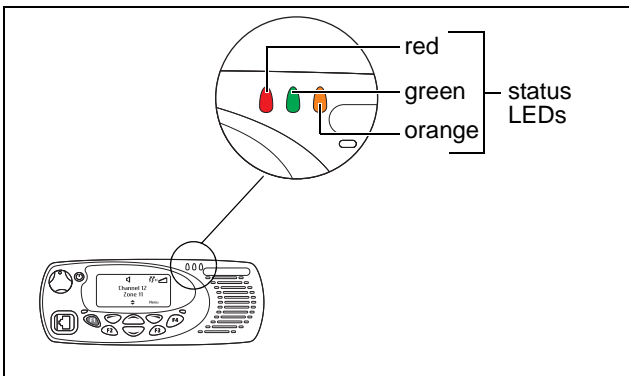

The status LED indicators and the radio's audible tones—together with the radio display—all combine to give you information about the state of your radio.

The most common way the indicators work is described in the following sections.

 The way these indicators behave may be affected by the way your radio is programmed.

Status indicators



Color		Meaning
Red (transmit)		On: your radio is transmitting
		Flashing: your transmit timer is about to expire
Green (receive)		On: the current channel is busy
		Flashing: you have received a call or monitor is active
Orange (network)		Off: No service
		Flashing: Limited service (no inter-site or fixed network services are available)
		On: Full service For more information see "Checking that your network is available" on page 89.

Audible tones

The radio uses audible tones to alert you to its status:

- Radio controls and keypress tones—the tones and beeps you hear when you press your radio's keys or use the controls.
- Incoming call tone—when the radio is receiving a call.
- Warning tones—when there is an error.



Warning If quiet or silent mode is turned on, you will not hear any alert tones.

Some of the more common audible tones are described below:

Tone	Meaning
One short beep	<ul style="list-style-type: none">■ Valid keypress: The action you have attempted is permitted.■ Function activated: A function has been turned on (using a function key).
One short, low-pitched beep	Function deactivated: A function has been turned off (using a function key).
One long, low-pitched beep	<ul style="list-style-type: none">■ Invalid keypress: The action you have attempted is not permitted.■ Transmission inhibited: You have attempted to transmit, but for some reason you cannot make a call at this time.
Two short beeps	<ul style="list-style-type: none">■ Radio turned on: The radio is powered on and ready to use.■ Radio is revived: The radio has been made operable by your service provider.
Three short beeps	Channel now free: You were prevented from transmitting on a busy channel and that channel is now free.

Tone	Meaning
Three long beeps	Transmit timeout imminent: Your transmit timer will expire and your current transmission will be terminated.
one short, high-pitched beep	Radio is stunned: The radio has been made inoperable by your service provider.
two low-pitched beeps	Radio's temperature is high: The radio's temperature is in the high-temperature range, but the radio will continue to operate.
two high-pitched beeps	Radio's temperature is very high: The radio's temperature is in the very high temperature range and all transmissions will now be at low power; if the radio's temperature rises outside this range, transmissions will be inhibited. Turn off the radio and allow it to cool down.
Continuous low-pitched tone	Radio system error: A system error has occurred and the radio may be inoperable. Contact your radio provider.
two long high-low pitched tone pairs	Synthesizer is out-of-lock: The radio's synthesizer is out-of-lock on the current channel and you cannot operate on that channel (Out of lock appears on the display).

Voice annunciation

In conventional mode, your radio may be programmed to play a pre-recorded message for the start-up zone and channel, and when changing the zone or channel.

In trunked mode, your radio may be programmed to play a pre-recorded message for the start-up zone, workgroup or preset, and when changing the zone, workgroup or preset.

In both modes, your radio may be programmed to play a pre-recorded message when loneworker monitoring has been turned on or off.

Using function keys to access frequently used features

The function keys provide access to some of the features you use most often. These features are assigned to the function keys when the radio is programmed. Some keys may have a feature associated with both a short key press and a long key press.

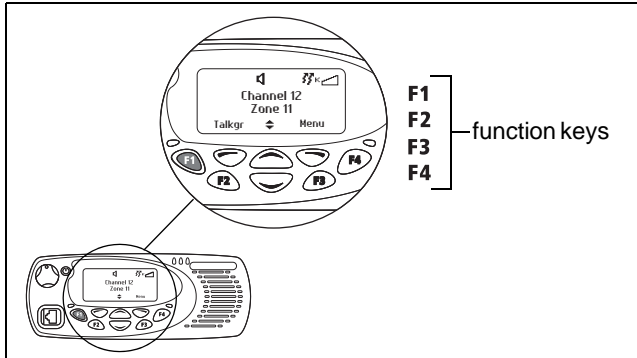

Viewing the function key settings

Use the Main menu to check the features assigned to your radio's function keys:

- 1 Press **Menu** and select **Radio settings > Radio info > Key settings**.
- 2 In the **Key Settings** menu, scroll through the list of function keys.
- 3 Press **Select** to view details of the function associated with a particular function key.

The example shown is for a function key programmed to turn backlighting on and off.



- 4 Press **Back** to return to the **Key Settings** menu.

Use the following table to record the function keys programmed for your radio:

	Short key press	Long key press
F1		
F2		
F3		
F4		

For more information about the function keys that can be programmed on your radio, contact your radio provider.

Navigating the radio's menus

Your radio has a number of menus, each containing lists or submenus. The menus available depend on the way your radio is programmed.

To access the Main menu, press the right selection key whenever **Menu** appears above it.

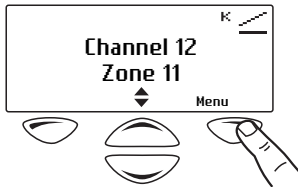

Use the scroll keys to move through the menu list.

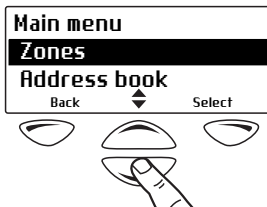

When the menu you want is highlighted, press **Select** to open the menu you have chosen.

Your radio may be programmed to use the scroll keys or the left selection key to directly access a menu.



To quickly exit the menu system, press and hold the left selection key when the word **Cancel** or **Back** appears above it.

Using the alphanumeric keys to search a list



This feature is only available for radios with alphanumeric keys.

If a blinking cursor appears when you select a list, you are able to search for the menu item you want using the alphanumeric keys. This is of particular benefit if you have a large number of items in a list.

Lists that you may be able to search are channels, zones, workgroups, and preset calls.

- To search a list, enter the required name using the keypad.

3 Basic operation

This section describes the basic operation of your radio.

This section covers:

- [Turning the radio on and off](#)
- [Adjusting the speaker volume](#)
- [Locking and unlocking the keypad](#)
- [Changing the radio's operating mode](#)
- [Setting and viewing the radio's time and date](#)

Turning the radio on and off

Long press the on/off key to turn the radio either on or off.

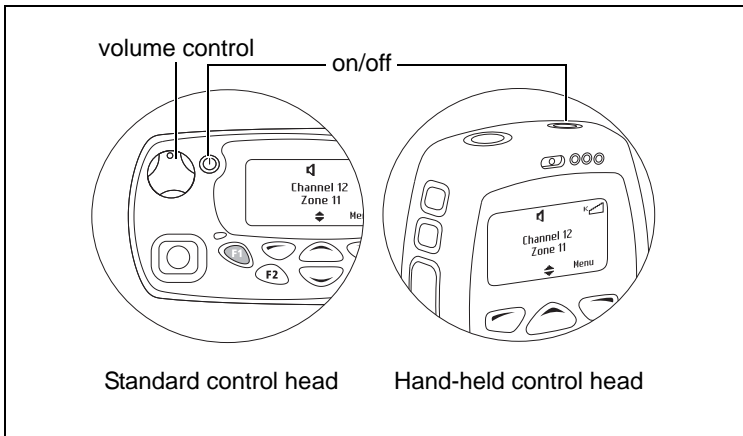

When the radio is first turned on, the red, green, and orange LEDs flash briefly, and the radio gives two short beeps. A brief message may appear on the display.

Security lock on power-up feature

Your radio may be automatically locked each time it is powered-up. If the message **Enter PIN** appears on the display, enter your assigned PIN (personal identification number). See [“Unlocking the radio”](#) below.

Locking the radio

- 1 Press **Menu** and select **Radio settings > Functions > Lock radio**. (Depending on how your radio is programmed, you may be able to press a function key to turn radio lock on and off.)
- 2 Scroll to either **On** or **Off** and press **Select**. (The current setting is highlighted.)

The radio is now locked, and the message **Enter PIN** appears on the display.

The radio remains locked until the correct sequence of keys is pressed. If you forget the unlock sequence or you do not know it, contact your radio provider for assistance.

Unlocking the radio

- To unlock your radio, use the unlock sequence you have been given. (This is a pre-programmed sequence of four keys.)

Adjusting the speaker volume

Standard control head

Rotate the volume control clockwise to increase the speaker volume and counterclockwise to decrease the volume. The raised dot indicates the current volume setting.

Hand-held control head

Press ⊕ to increase the speaker volume, and ⊖ to decrease the volume.

- ⓘ The volume control also changes the volume level of the radio's audible indicators.

Locking and unlocking the keypad

The keypad lock feature prevents you from pressing a key accidentally. The number of keys that are locked depends on the way your radio is programmed.

If you receive a call while the keypad is locked, press any key to answer.

To lock the keypad:

- Press and hold the right selection key for about one second.

The message **Keypad locked** briefly appears on the display, and **Unlock** appears above the right selection key, in place of **Menu**.

When any of the locked keys are pressed, the message **Keypad lock active** appears.

To unlock the keypad:

- Press and hold the right selection key for about one second.

Changing the radio's operating mode

The way your radio performs basic functions, such as sending and receiving calls, depends on the operating mode of your network. The two operating modes that may be available on your radio are:

- conventional mode (see "[Operating in conventional mode](#)" on page 49), and
- trunked mode (see "[Operating in trunked mode](#)" on page 89).

To change your operating mode:

- 1 Press **Menu** and select **Change mode**.

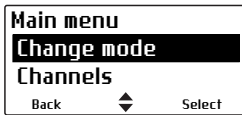

(Depending on how your radio is programmed, you may be able to press a function key to change mode.)

- 2 Select **Yes** to confirm your selection, and your radio now shows the default display for either trunked or conventional.

The following examples show typical default displays for trunked and conventional modes.



trunked mode

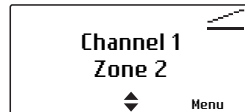

conventional mode

Setting and viewing the radio's time and date

Your radio may be programmed to use its internal real-time clock. You may be able to view the time and date via a function key or via the radio menu. Other features may also make use of the radio's time and date by showing entries based on the current clock setting.

To set the time, date, and time format:

 Your radio may be programmed to allow you to set time and date manually, or time and date can be updated using a GPS source.

- 1 Press **Menu** and select **Time and Date** and the corresponding option.
- 2 Follow the prompts on the display.

To view the time and date:

- Press **Menu** and select **Time and Date > View clock** (Depending on how your radio is programmed, you may be able to press a function key to view the time and date).

4 Using the address book

Your radio may have a standard address book (with pre-programmed entries) and a personal address book which allows you to maintain your own entries.

The address book only shows entries that are relevant to your radio's current mode of operation (conventional or trunked) and network.

The standard address book may be grouped by roles, but you can also select to display all entries.

The standard address book can also contain entries that are hidden from the radio user. These hidden entries are used to identify incoming calls from known sources.

This section covers:

- [Opening the address book](#)
- [Changing the default address book](#)
- [Navigating the address book](#)
- [Filtering address book lists](#)
- [Maintaining personal address book entries](#)

Opening the address book

To open the address book:

- Press **Menu** and select **Address book**.

 Your radio may be programmed to use the left selection key (**Ad. book**) or a function key to open the address book.

When opening the address book for the first time after turning on the radio or changing the mode, you are asked to select the default address book:

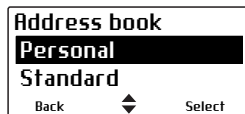

The radio will now default to the selected address book.

Changing the default address book

To change the default address book:

- 1 Press **Menu** and select **Address book**.

The standard or personal address book appears.

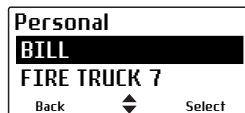

- 2 Press **Back**.

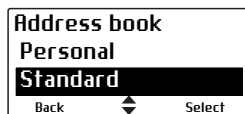

You can now select the default address book.

Navigating the address book

In the standard address book, each entry may have been assigned to a role. Roles are used to categorise entries into logical groups. When opening the standard address book, you can view all entries or filter the entries by a particular role.

The personal address book always lists all entries.

1 Press **Menu** and select **Address book**.

In the standard address book, you can now select to view all entries or select to view the entries of a role.

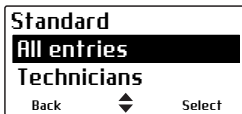

2 Scroll to the role you want, and press **Select**.

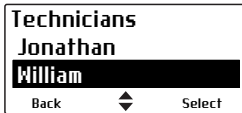

All entries associated with the selected role are now displayed.

3 Scroll to the entry you want.

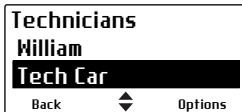

4 Press the PTT key to make a call.

5 You can also press **Options** to:

- call the address or select the channel (same as pressing PTT)
- send a status, text message, emergency or priority call (depending on the type of entry)
- view the entry details

- add an entry of the standard address book to your personal address book
- ① If the number of an incoming or dialed call occurs in both the standard and the personal address books, the radio will display the name defined in the personal address book.
- ① When adding an entry from the standard address book to the personal address, the role is added as well.
- add, edit or delete entries in the personal address book, including adding the last call

Filtering address book lists

You can use this method to select a role or entry if you know its name.

- In the roles or entries list, start typing the name (e.g. for 'Jonathan' press **5** (J) and **6** (o)) until the desired role or entry appears.



Maintaining personal address book entries

The personal address book allows you to:

- create, edit and delete entries
- add the last caller
- copy entries from the standard address book

The personal address book can contain up to 100 entries.

New address book entries are only relevant to your radio's current mode of operation (conventional or trunked) and network.

Creating, editing and deleting personal address book entries

To manually create a personal address book entry:



To edit or delete entries, select the corresponding option.

- 1 Press **Menu** and select **Address book**.

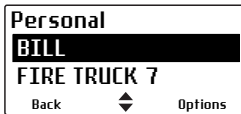

If the standard address book appears, press **Back** and switch to the personal address book.

- 2 Press **Options** and select **New entry**.
- 3 Enter the name.

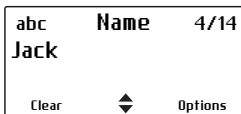

Press **Clear** to correct any mistakes.

Press **Options** and select **Next**.

- 4 In conventional mode, select the **Entry type**.

DMR conventional

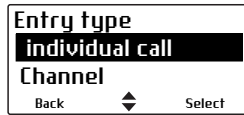

A screen titled "Entry type" with a dropdown menu showing "individual call" and "Channel". At the bottom are "Back" and "Select" buttons with a diamond icon between them.

Analog conventional



A screen titled "Entry type" with a dropdown menu showing "Channel" and "Text message ID". At the bottom are "Back" and "Select" buttons with a diamond icon between them.

Press **Select**.

- 5 Enter the number or channel.

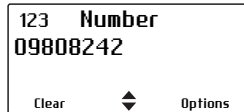

A screen titled "123 Number" with the input field containing "09808242". At the bottom are "Clear" and "Options" buttons with a diamond icon between them.



A screen titled "123 Channel" with the input field containing "200". At the bottom are "Clear" and "Options" buttons with a diamond icon between them.

Press **Options** and select **Save**.

Adding the last caller to the personal address book

If you received an individual call or a text message, you can add the caller to the personal address book:

- 1 Press **Menu** and select **Address book**.

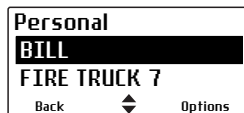

A screen titled "Personal" with a dropdown menu showing "BILL" and "FIRE TRUCK 7". At the bottom are "Back" and "Options" buttons with a diamond icon between them.

If the standard address book appears, press **Back** and switch to the personal address book.

- 2 Press **Options** and select **Add last call**.

 **Add last call** only appears, if you received an individual call (all modes except analog conventional) or a text message.

- 3 Enter or edit the name.

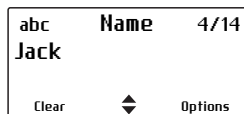

A screen titled "abc Name 4/14" with the input field containing "Jack". At the bottom are "Clear" and "Options" buttons with a diamond icon between them.

Press **Clear** to correct any mistakes.

Press **Options** and select **Next**.

- 4 In trunked mode, the number of the last call appears on the display.

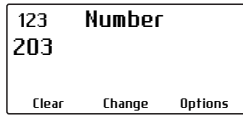

If you want to edit the number, press **Change**. Otherwise, press **Options** and select **Save**.

- 5 In conventional mode, select the **Entry details** screen appears showing the radio ID of the last caller:

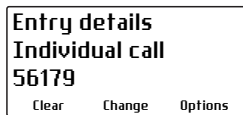

If you want to edit the details, press **Change**. Otherwise, press **Options** and select **Save**.

Copying a standard address book entry to the personal address book

To copy a standard address book entry to the personal address book:

- 1 Press **Menu** and select **Address book**.



If the personal address book appears, press **Back** and switch to the standard address book.

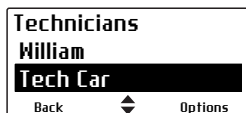

- 2 Select a standard address book entry (from a role or all entries) and press **Select**.

-  The entry types Talkgroup and Status Update cannot be copied to the personal address book.



3 Press **Options** and select **Add to personal**.

You can now go to the personal address book and change the new entry to make corrections to the name or number.

-  If the number of an incoming or dialed call occurs in both the standard and the personal address books, the radio will display the name defined in the personal address book.
-  If the entry from the standard address book has a role assigned, the role will also be copied to the personal address book. In this case the personal address book will display the role in a second line.

5 Operating in conventional mode

This section explains how to operate your radio on a conventional network (digital and analog).

This section covers:

- Selecting a zone
- Selecting a channel
- Selecting a scan or voting group
- Understanding talk-groups
- Making a call
- Making an individual call
- Making a preset call
- Making a call using the address book
- Making a local call
- Making a DTMF patch call
- Making an emergency call
- Setting your status (on analog channels)
- Sending and receiving status messages
- Sending and receiving text messages
- Checking the queue
- Call alert
- Radio check
- Radio monitor
- Radio inhibit and uninhibit
- Resending calls automatically
- Transmitting at low power
- Ending active calls
- Using monitor and squelch override (on analog channels)
- Bypassing the repeater (on analog channels)
- Receiving a call
- Using the radio in different repeater areas
- Scanning a group of channels

Selecting a zone

Your radio may be programmed to use zones, which are collections of channels and groups. When you select a zone, only the channels and groups assigned to that zone are available.

Using the Main menu:

- 1 Press **Menu** and select **Zones**.



(Depending on how your radio is programmed, you may be able to use the scroll keys or left selection key to select the **Zones** menu.)

- 2 In the **Zones** menu, scroll through the list of zones until the one you want appears.

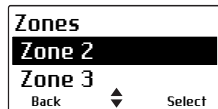

- 3 Press **Select**, and the zone indication appears either below the channel information, beside the RSSI icon, or in both positions.

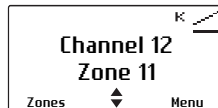

When changing a zone, the first channel in the new zone is selected.

Selecting a channel

-  For DMR digital channels, a talk group may be assigned to a channel. For more information, see "[Understanding talkgroups](#)" on page 54.

Using the scroll keys:

Your radio may be programmed to use the scroll keys to scroll through the channels.

Using the Main menu:

- 1 Press **Menu** and select **Channels**.



(Depending on how your radio is programmed, you may be able to use the scroll keys, the left selection key or a function key to select the **Channels** menu.)

- 2 In the **Channels** menu, scroll through the list of channels until the channel you want appears.

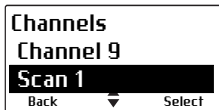

- 3 Press **Select**, and the programmed channel is now shown on the display.

Dialing a channel

-  This feature is only available for radios with alphanumeric keys.

Dialing a channel may be available from the radio's idle display but is always available while in the **Channels** menu.

- 1 Dial the number associated with the channel using the alphanumeric keys.



- 2 Press **Select**, and the programmed channel is now shown on the display.

Automatic channel selection

Your radio may be configured to change channels automatically based on your location.

Selecting a channel manually as described above will end automatic mode, and the manual mode icon  will appear on the display.

Your radio may be configured to use a timer or a function key to return to automatic mode.

Selecting a scan or voting group

A scan or voting group is a collection of channels that are grouped together for either scanning or voting. In the **Channels** menu, the scan or voting group is shown as being a single channel item, e.g. "Scan1".

The sections ["Using the radio in different repeater areas" on page 82](#) and ["Scanning a group of channels" on page 83](#) explain how your radio operates once a scan or voting group has been selected.

Using the Main menu

- 1 Press **Menu** and select **Channels**.



(Depending on how your radio is programmed, you may be able to use a function key, the scroll keys or left selection key to select a group.)

- 2 In the **Channels** menu, scroll through the list of channels and groups until the group you want appears.

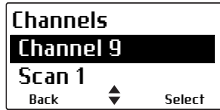

- 3 Press **Select**, and the programmed scan or voting group is now shown on the display. The orange LED glows and the scanning icon  appears on the display.



Dialing a scan or voting group

-  This feature is only available for radios with alphanumeric keys.

Dialing a scan or voting group may be available from the radio's idle display but is always available while in the **Channels** menu.

To dial the group number from the default display:

- 1 Dial the number associated with the scan or voting group using the alphanumeric keys.

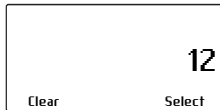

- 2 Press **Select**, and the programmed scan or voting group is now shown on the display. The orange LED glows and the scanning icon  appears on the display.

Understanding talkgroups

This feature is available for DMR digital channels only.

A talkgroup is a collection of radio users with whom you want to have private conversations. For example, a state's public safety agencies could have the following talkgroups:

- Local talkgroups—used by a specific agency to communicate within their own local agency. It may even be made up of a county of public safety officers.
- Regional talkgroups—used by large state agencies that have regional divisions.
- Statewide talkgroups—used by an agency to communicate with public safety members in other regions. Statewide talkgroups, as their name suggests, enable public safety agencies to communicate with each other from one end of the state to the other.
- Special event talkgroups—may be used to manage emergencies encompassing a large area, or even events such as visits by heads of state.

Talkgroups can be assigned to each channel, to allow a users to:

- initiate a call to a talkgroup by pressing PTT
- listen and respond to conversations on none, one or multiple talkgroups

The channel may be named to reflect its talkgroup association. When making a call, the talkgroup name will appear.

Your radio may also be programmed to show the **Talkgroups** menu which allows you to change the talkgroup you want to call and listen to on the current channel.

Making a call

The radio's behavior when making a call changes depending on the type of channel selected.

Channels can be programmed for:

- DMR calls over a DMR network
- DMR calls between radios
- analog calls between radios

If you are on a channel programmed for calls over the DMR network, the green LED indicates whether the network is active. By default, the network is inactive (green LED is off).

Initiating a call will activate the network which will remain active for a programmed time. While the network is active (green LED glows), you can complete the call and start a new call.

If you are on a channel programmed for DMR or analog calls between radios (without a radio network), the green LED indicates activity on the channel, i.e. whether someone is talking.

For all DMR calls (over the network or radio to radio), you may hear a go-ahead double-beep after pressing the PTT key (if programmed).

The radio may be programmed to ring or beep when a new DMR call is received.

DMR calls have an inactivity timeout. If a pause in the conversation exceeds the timeout, the next press of the PTT key will establish a new call.

To make a call:

- 1 Select the required channel or scan group.
 -  You may need to select the zone you want first, then select the channel or group from that zone.
- 2 On channels programmed for DMR or analog calls between radios (without a radio network): Check that the channel is clear. If the green LED is glowing, the channel is busy and you may not be able to transmit.
- 3 Lift the microphone off the microphone clip.
- 4 Hold the microphone about 2 inches (5cm) from your mouth.
- 5 Press and hold the PTT key to transmit.
- 6 On a DMR channel: Wait for the go-ahead double-beep (if programmed).
- 7 Speak clearly into the microphone and release the PTT key when you have finished talking.

While you are transmitting, the red LED glows and the transmit icon  appears on the display.

-  You cannot change channels while transmitting.

Limiting call time

Your radio may limit the amount of time you can talk (transmit) continuously. This is known as the 'transmit timer' or 'time-out timer' and allows other radio users to make calls on that channel.

The radio warns you before the transmit timer expires by beeping three times. The red status LED flashes and the message **Transmit timeout imminent** appears in the display.

If the transmit timer has timed out, you must release the PTT before you can transmit again.

-  Your radio may be unable to transmit for a short time after the transmit timer has expired.

Making an individual call

This feature is available for DMR digital channels only.

To make a call to one person:

- 1 Press **Menu** and select **Individual call**.

(Depending on how your radio is programmed, you may be able to use a function key to select individual calls.)

- 2 If no address book is configured, a preconfigured list appears. The person to whom you last made an individual call is highlighted.

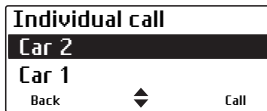

Scroll to the person you want to call and press the PTT key to make the call immediately.

(Alternatively, you can press **Call** and then PTT.)

- 3 If an address book is configured, you can select to either dial a number or show the address book.

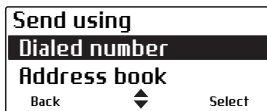

Making a preset call

Your radio may be programmed to use a function key to initiate a call to an individual or group that may or may not be part of your current talkgroup (e.g. the dispatcher).

Making a call using the address book

The **Address book** menu has a programmed list of calls.

When on a DMR conventional channel, the address book will show the DMR entries available on the current channel as well as all analog entries. When on an analog channel, the address book will show all analog entries. When selecting an analog entry, the radio will change channel if necessary.

Address book calls may also be used to send status information, such as “at lunch” or “on site”, or to change to a channel or group. For more information, see ["Using the address book" on page 41](#).

- 1 Press **Menu** and select **Address book**.

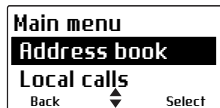

(Depending on how your radio is programmed, you may be able to use the scroll keys, left selection key or a function key to select the **Address book** menu.)

- 2 In the **Address book** menu, scroll through the list of calls until the call you want appears.
- 3 Press **Options** and **Call**, or press PTT.

The call details appear on the display, the red LED glows, and  appears on the display.

Making a local call

Each channel on your radio may have one or more local calls programmed.

- 1 Select the required channel.
- 2 Press **Menu** and select **Local calls**.

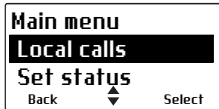

- 3 In the **Local calls** menu, scroll through the list of local calls until the call you want appears.
- 4 Press **Send**.

The call details appear on the display, the red LED glows, and **↻** appears on the display.

Dialing a radio call

 This feature is only available for radios with alphanumeric keys.

To dial a call to another radio, or group of radios (analog only):

- 1 Select the required channel.
- 2 Press **Menu** and select **Dial radio call**.

Alternatively, your radio may be programmed so a call can be dialed directly from the default display. In this case, you can start dialing the call without selecting the menu option.

On an analog channel, a series of **X** and **S** characters may appear, prompting you to dial over them.

- 3 Dial the number using the alphanumeric keys.

 On an analog channel, your radio may be programmed so you can dial group tones using the * and # keys. Dial * to fill one X. Dial # to fill the current X and all subsequent X characters in the current burst.

- 4 For DMR conventional calls, press the PTT key to make the call immediately. You can also press **Call** and then PTT.

For analog calls, press **Send**.

The call details appear on the display, the red LED glows, and  appears on the display.

On an analog channel, when the called party receives your call, the message **Ack received** may appear on the display.

Making a phone call

This feature is available for DMR digital channels only.

You may be able to connect directly to a telephone network by dialing the number yourself or using preset dialing sequences.

- 1 Select the required channel.
- 2 Press **Menu** and select **Phone call**.

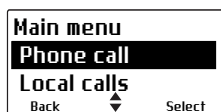

- 3 If an address book is configured, you can select to either dial a number or show the address book.

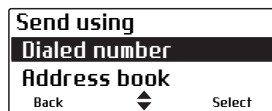

Otherwise you can only dial a number.



4 Press **Call**.

The call details appear on the display, the red LED glows, and  appears on the display.

Making a DTMF patch call

You may be able use DTMF patch dialing to connect to a telephone network or signal another device by dialing the number yourself or using preset dialing sequences.

You may be able to either:

- use a programmed function key
- use the Main menu to dial the call
- make a local call (see ["Making a local call" on page 59](#))
- use your address book (see ["Making a call using the address book" on page 58](#))
- dial DTMF tones (overdialing)

Using a function key

 Depending on how DTMF patch calls are programmed, some or the following steps may not be necessary.

- 1 Select the required channel.
- 2 Press the function key programmed for DTMF patch call.

Your radio may send tones to capture the line.

- 3 Press **Send**, or press the function key a second time, to send the preset number.

You may hear telephone dialing and ringing tones.

- 4 Proceed with your call.
- 5 Press **End**, or give a long press on the function key, to end the call.

Your radio may send tones to release the line.

Using the Main menu



This feature is only available for radios with alphanumeric keys.

To dial a DTMF patch call by using the Main menu:



Depending on how DTMF patch calls are programmed, some or the following steps may not be necessary.

- 1 Select the required channel.
- 2 Press **Menu** and select **Dial patch call**.
- 3 Dial the required number using the alphanumeric keys.
- 4 Press **Send**.

Your radio may send tones to capture the line.

- 5 Press **Send** to send the number dialed in step 3.

You may hear telephone dialing and ringing tones.

- 6 Proceed with your call.
- 7 Once the call has finished, press **End**.

Your radio may send tones to release the line.

Dialing DTMF tones (overdialing)

Your radio may be programmed to allow dialing of DTMF tones using the numeric keypad while on a channel or in a call. The dialing may be either sent out immediately (as you type) or sent after pressing **Send**.

Making an emergency call

You may be able to activate emergency mode by using a programmed function key.

- 1 Press the function key programmed for Emergency Mode and an emergency call is sent to your dispatcher, or some other predetermined location.

While emergency mode is active, your radio may automatically cycle between receive and transmit, so that your dispatcher can hear any activity near the radio. Alternatively, your radio may appear to turn off but will actually remain in emergency mode.

- 2 Reset the radio to normal operation at any time by turning the radio off and then on.

 Emergency mode may be programmed to end after a fixed period of time. In this case, there is no need to turn the radio off and then on in order to return the radio to normal operation.

Setting your status (on analog channels)

For analog channels, your radio may be able to maintain a record of your current status. This status may be sent with outgoing calls programmed to contain status information. If the radio receiving your call has been programmed with the same status messages, it will decode and display your status. The status indicates your current activity or location, such as “en route” or “at lunch”.

To change your current status:

- 1 Press **Menu** and select **Set status**.



- 2 In the **Set status** menu, scroll through the list of status messages until the message you want appears.
- 3 Press **Select**. The message **Status updated** appears on the display.

Sending and receiving status messages

A status message is sent to another party to indicate your current activity or location, such as “en route” or “at lunch”. If the radio receiving your message has been programmed with the same status messages, it will decode and display your message. If you receive a status message, the message is automatically queued, since a response is not expected.

Status messages can also be used to control external devices.

Sending a status message

- 1 Press **Menu** and select **Services > Status update**.
- 2 In the **Status update** menu, scroll through the list of status messages until the message you want appears.



- 3 When you have chosen a message, press **Select**.



Depending on how radio is programmed, the message may be sent directly to a preconfigured radio or group, or you are presented with options to select a destination.

The call details appear on the display.

Receiving a status message

If the radio is programmed for call queuing, incoming status messages are added to the queue. For more information, see ["Checking the queue" on page 69](#).

Press **Options** and select whether to reply, call or delete.

Your radio may be programmed to automatically view status messages on receipt.

If the radio is not programmed for call queuing, incoming status messages are displayed briefly.

Sending and receiving text messages

Your radio may be programmed so that you can send text messages. The three options for creating text messages are selecting a preset text message, editing a draft text message, or creating a new text message.



To either edit or enter a text message, your radio must have alphanumeric keys.

Using the alphanumeric keys to enter text

When the alphanumeric keys are used to enter a text message, they have special functions.

- Use the **#** key to select the type of text entry: upper and lower case characters (**ABC**, **abc**), initial capitals (**Abc**), or numbers (**123**).
- Use the left selection key (**Clear**) to delete a character from the display.
- Use the scroll keys to move through a message.

Repeated presses of these keys will give you the characters shown in the following table.

Key	Characters	Key	Characters
1	. , ? ! - / 1	7 PQRS	P Q R S 7
2 ABC	A B C 2	8 TUV	T U V 8
3 DEF	D E F 3	9 WXYZ	W X Y Z 9
4 GHI	G H I 4	0	space 0
5 JKL	J K L 5		
6 MNO	M N O 6		

In the example below, a preset text message has been selected, and is being edited.

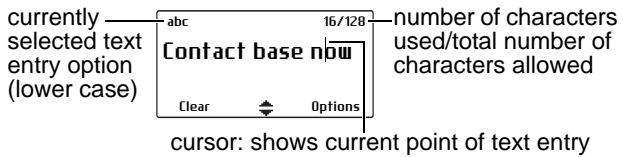

Sending a preset text message

- 1 Press **Menu** and select **Services > Text message > Preset message**.



In the **Preset message** menu, a short label representing each message is displayed.



- 2 Scroll through the list of preset message labels until the one you want appears.

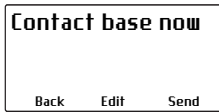

- 3 Press **Select**, and the text message you have chosen is now displayed.



- 4 Press **Send** to send the message, or **Edit** to change the message.

Pressing  will place the cursor at the start of the message. Pressing  will place the cursor at the end of the message.

- 5 When the message is complete, press **Options** and select **Send**.

Creating a new text message

- 1 Press **Menu** and select **Services > Text message > New message**.
- 2 Use the alphanumeric keys to add characters and the **Clear** key to delete them. Use the scroll keys to move through the characters.



- 3 When the message is complete, press **Options** and select **Send**.

If you decide to cancel out of editing a text message or receive a call while editing, the current draft will be saved and is available for editing later.

Editing a draft text message

- 1 Press **Menu** and select **Services > Text message > Edit message**.

The last sent or edited text message will appear.

- 2 Use the scroll keys to move through the characters. Use the alphanumeric keys to add characters and the **Clear** key to delete them.



- 3 When the message is complete, press **Options** and select **Send**.

If you decide to cancel out of editing a text message or receive a call while editing, the current draft will be saved and is available for editing later.

Sending a text message

- 1 When you have chosen or entered a message, press **Options** and the **Text options** menu opens.

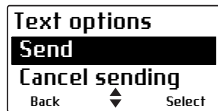

- 2 In the **Text options** menu, scroll through the list of options until the choice you want appears.
- 3 Select **Send** and press **Select**.
- 4 If an address book is configured, you can select to either dial a number or show the address book.

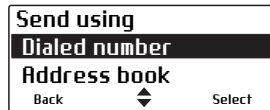

Otherwise a preset list of radios will appear.

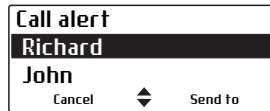

The call details appear on the display.

Receiving a text message

If the radio is programmed for call queuing, incoming text messages are added to the queue. For more information, see ["Checking the queue" on page 69](#).

Press **Options** and select whether to reply, call or delete.

Your radio may be programmed to automatically view text messages on receipt.

If the radio is not programmed for call queuing, incoming text messages will not be stored or displayed.

Checking the queue

If you have missed an incoming call or call alert, or if you received a status message or text message, it may be stored in the queue. The queue icon  appears and information about the missed call or message may be shown on the display.

The queue can be programmed to store multiple calls or messages or just the last call or message.

In the example below, a status message was received from Car 1. This is the first of three calls or messages stored in the queue.

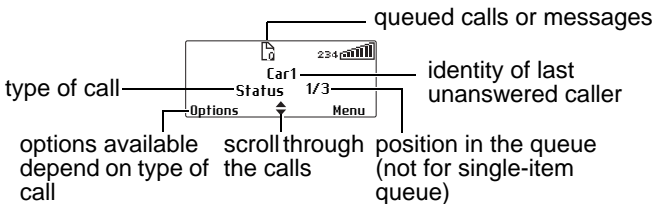

Press **Options** to either view, reply, call back, look at the entry details, or delete the entry.

Your radio may be also programmed to automatically view the full status update or text message on receipt.

If there are calls or messages in the queue, the radio may emit a warble tone for a period of time. The notification starts again when the radio is restarted or another call is received.

Accessing the queue

- 1 If the call or message information is not shown already, press **Menu > Call queue**.

(Depending on how your radio is programmed, you may be able to press a function key to access the queue.)

- 2 Use the scroll keys to move through the calls or messages in the queue until the item you want appears.
- 3 Press **Options**.

The options available depend on the type of call it is. For a voice call, select **Call** to return the call.

For a status message or a text message, select **View** to read the message, **Reply** to reply, or **Call** to return the call.

Your radio may be also programmed to automatically view the full status update or text message on receipt.

You can also delete the selected call or messages, or delete all queued calls and messages.

Call alert

This feature is available for DMR digital channels only.

You can let another radio user know that you want to talk to them by sending them a call alert page. When the other radio user receives the call alert page, they can call you back when it is convenient.

If you are on a DMR conventional channel, you can send a call alert to any other radio on the same DMR conventional channel.

To send a call alert page:

- 1 Press **Menu** and select **Services > Call alert**.

 You can also send a call alert from the **Options** > **Services** menu of an address book entry.

- 2 If an address book is configured, you can select to either dial a number or show the address book.

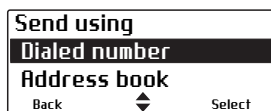

Otherwise a preset list of radios will appear.



- 3 Select the radio you want to page.
- 4 Press **Send to**.

A message appears in the display.



The red LED glows and a message will be displayed to advise you whether the call alert has been sent successfully or not.

If an acknowledgement is not received from the recipient's radio, you will have the option of either canceling or resending the request.

Answering a call alert page

If you receive a call alert page from another radio user, the message **Call alert** and the name of the caller appears on the display.

Select **Call** to return the page or **Clear** to delete it. If you miss the call alert page, a call alert entry is added to the queue. See "[Checking the queue](#)" on page 69.

Radio check

This feature is available for DMR digital channels only.

If you want to find out whether a particular radio is available on the same DMR conventional channel, you can use the radio check feature. This sends a radio check message to the radio unit you have specified.

- 1 Press **Menu** and select **Services > Radio check**.

 You can also check a radio from the **Options** menu of its address book entry.

- 2 If an address book is configured, you can select to either dial a number or show the address book.

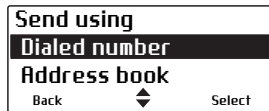

Otherwise a preset list of radios will appear.

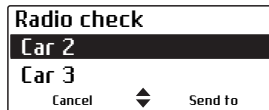

- 3 Scroll to the radio you want to check.
- 4 Press **Send to**.

The red LED glows and a message showing the destination appears in the display.



If the radio is available on the system, an acknowledgement message is displayed.

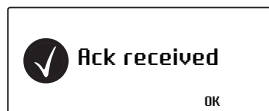

If an acknowledgement is not received from the recipient's radio, you will have the option of either canceling or resending the request.

Radio monitor

The radio unit monitor feature can be used when you are concerned about the safety of a radio user on the same DMR conventional channel. When you send a radio-unit monitor request to a radio, it calls you back without giving any indication that it is making a call. You can hear any activity near the radio for up to 120 seconds.

To send a radio unit monitor request:

- 1 Press **Menu** and select **Services** > **Radio monitor**.

 You can also send a radio unit monitor request from the **Options** menu of an address book entry.

- 2 If an address book is configured, you can select to either dial a number or show the address book.

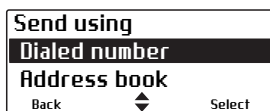

Otherwise a preset list of radios will appear.

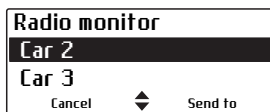

- 3 Scroll to the radio you want to monitor.
- 4 Press **Send to**.

The red LED glows and a message appears in the display.



If the other radio has received your request, it will now call you, so that you can monitor activity near the radio.

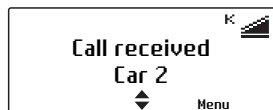

If an acknowledgement is not received from the recipient's radio, you will have the option of either canceling or resending the request.

Radio inhibit and uninhibit



Warning When a radio is immobilized ('inhibited'), the encryption keys may be automatically deleted from the radio.

If you want to inhibit another radio on the same DMR conventional channel, you can use the radio inhibit feature. This feature is also known as 'stun'.

On the inhibited radio, **Radio stunned** will appear briefly on the display, and the radio will return to the idle display. The radio remains inoperable even if it is turned off and then on again.

The radio cannot return to normal operation until it receives an uninhibit request. This is also known as 'revive'.

To send a radio inhibit request

- 1 Press **Menu** and select **Services > Radio inhibit**.



You can also inhibit another radio from the **Options** menu of its address book entry.

- 2 If an address book is configured, you can select to either dial a number or show the address book.

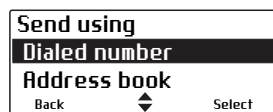

Otherwise a preset list of radios will appear.



- 3 Scroll to the radio you wish to make inoperable.
- 4 Press **Send to**.

The red LED glows and a message appears in the display.

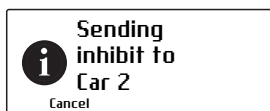

If the radio has been successfully immobilized, an acknowledgement message is displayed.



To send a radio uninhibit request:

- 1 Press **Menu** and select **Services > Radio uninhibit**.



You can also uninhibit another radio from the **Options** menu of its address book entry.

- 2 If an address book is configured, you can select to either dial a number or show the address book.

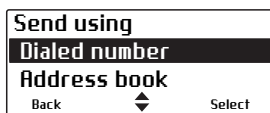

Otherwise a preset list of radios will appear.



- 3 Scroll to the radio you wish to make operable.
- 4 Press **Send to**.

The red LED glows and a message appears in the display.



If the radio has been successfully returned to operation, an acknowledgement message is displayed.

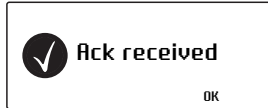

The uninhibited radio will briefly display **Radio revived**.

If an acknowledgement is not received from the recipient's radio, you will have the option of either canceling or resending the request.

Resending calls automatically

On an analog channel, your radio may have been programmed to resend individual and group calls when transmission is refused because the channel is busy.

There are two automatic callback features:

- deferred calling
- no acknowledgement retries

Deferred calling

When you attempt to make a call on a channel that is busy, the radio can store and send the call once the channel is free. The radio gives a low-pitched beep if the channel is busy, and then waits until the channel is free to retry the call.



A deferred calling time limit may have been configured. Once the time limit has expired the radio will no longer attempt to retry the call.

Any user interaction (such as pressing PTT) will cancel a deferred call.

No acknowledgement retries

When you send a call and there is no reply, the call is resent.

Any user interaction (such as pressing PTT) will cancel a call that is being resent.

Transmitting at low power

If you are using your radio in conditions where signal strength is high, you can reduce the drain on your vehicle battery by transmitting at low power.

When low power transmit is turned on,  appears on the display and calls are made at low power rather than at the programmed power setting.

Some channels may always transmit at low power.

To turn low power transmit on or off for all channels:

Using the Main Menu

- 1 Press **Menu** and select **Radio settings > Functions > Low power tx**.
- 2 Scroll to **On** (or **Off**) and press **Select**. (The current setting is highlighted.)

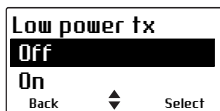

The message **Low power tx activated** (or **deactivated**) appears on the display.

Using a function key

- 1 Press the function key programmed for low-power transmit to transmit at low power on your current channel.

The message **Low power tx activated** appears briefly, and the low-power transmit icon  appears on the display.

- 2 Press the low-power transmit function key again to turn low-power transmit off, and the message **Low power tx deactivated** appears on the display.

Ending active calls

For analog channels, you may have a function key programmed to either end the current call, or end the current call and all other active calls in your group. This can be done either by:

- using the function key programmed for reset monitor to end your current call,
- using the function key programmed for call clear-down to end your current call and all other calls in your group, or
- using the function key programmed for both reset monitor and call clear-down.

Using a function key to end your current call

- Press the function key programmed for reset monitor. The radio's monitor is turned off, ending your current call.

The green LED stops flashing, and the monitor icon  disappears from the display.

Using a function key to end all active calls

- Press the function key programmed for call clear-down and monitor is turned off for all radios in your radio group.

The green LED stops flashing, and the monitor icon  disappears from the display.

Using the function key programmed for reset monitor/call cleardown to end active calls

The function key programmed for reset monitor may be programmed so that a short key press ends your current call, and a long key press ends all active calls in your group.

Using monitor and squelch override (on analog channels)

The monitor function allows you to override some or all of the radio's mutes, and hear if there is any traffic on a channel before you make a call.

The squelch override function lets the radio user override the squelch (carrier) mute and hear all noise on a channel, including weak signals that are below the programmed squelch threshold.

 Your radio may be programmed to activate monitor whenever the microphone is off the microphone clip.

To turn monitor on and off:

- 1 Press **Menu** and select **Radio settings > Functions > Monitor**.

(Depending on how your radio is programmed, you may be able to press a function key to toggle monitor on and off.)

- 2 Scroll to **On** (or **Off**) and press **Select**.

While monitor is on, the green LED flashes slowly and the monitor icon  appears in the display.

 Your radio may be programmed so that monitor turns off automatically after a short time.

To turn squelch on and off:

- 1 Press **Menu** and select **Radio settings > Functions > Squelch o'ride**.



Squelch is often programmed as a long keypress of the same function key that turns monitor on and off.

- 2 Scroll to **On** (or **Off**) and press **Select**.

This allows you to hear even faint and noisy signals. While squelch override is on, the green LED flashes continually, and the squelch override icon  appears on the display.



Press the monitor function key again to return the radio to a quiet state.



Squelch cannot be overridden when the radio is scanning.

Bypassing the repeater (on analog channels)

For analog channels, you can bypass the radio repeater and communicate directly with another radio. This feature is known as repeater talkaround. You can do this, for example, when you are out of range of the repeater, or if the repeater is busy or stops working. While repeater talkaround is active, all transmissions are made on the receive frequency of the channel you are on.

To activate repeater talkaround, you may be able to either use a programmed function key, or use the Main menu.

Using the Main menu

- 1 Select the required channel.
- 2 Press **Menu** and select **Radio settings > Functions > Talkaround**.
- 3 In the **Talkaround** menu, choose **On**.

- 4 Press **Select**. The message **Talkaround activated** appears briefly, and the repeater talkaround icon  appears on the display.
- 5 Proceed with your call.
- 6 To turn repeater talkaround off, either change the channel, or choose **Off** in the **Talkaround** menu.

Using a function key

- 1 Select the required channel.
- 2 Press the programmed function key to turn repeater talkaround on. The message **Talkaround activated** appears briefly, and the repeater talkaround icon  appears on the display.
- 3 Proceed with your call.
- 4 To turn repeater talkaround off, either change the channel, or press the function key again.

Receiving a call

When there is valid activity on your radio's currently selected channel or group, the radio then unmutes and you can hear the call.

If an incoming call contains special signaling that matches the signaling programmed for your radio, the green LED lights up and your radio may give a ringing tone.

Using the radio in different repeater areas

Your radio may have a group of channels programmed as a voting group. The channels in the voting group all carry the same traffic, but from different repeaters. As your radio moves in and out of different repeater coverage areas, the best communication channel is automatically selected for you to use.

This channel is known as the 'home' channel, and will be the channel you make and receive calls on. While voting is active, the orange LED glows and the scanning icon  appears on the display.

The section "[Selecting a scan or voting group](#)" on [page 52](#) explains how to select a group. A group can be either a voting or a scanning group.

Suspending a channel from a voting group

You may be able to use the function key programmed for nuisance delete to temporarily delete one of the channels from the voting group.

When that voting group is next selected, or after the radio has been turned off and then on, the deleted channel is again part of the voting group.

Alternatively, the function key programmed for voting may be programmed so that a short key press turns on voting, and a long key press activates nuisance delete.

- Press and hold the function key programmed for voting to remove the current channel from the voting group.

If the operation has been successful, the message **Channel nuisance deleted** appears on the display.

Scanning a group of channels

The scan function is used to monitor a programmed group of channels, looking for activity. While the radio is scanning for activity, the orange LED glows and the scanning icon  appears on the display. When activity is detected on a channel in the scan group, the radio stops on that channel. The orange LED begins flashing, the radio unmutes and you can hear the call. Scanning resumes once the channel is no longer busy.

The section "[Selecting a scan or voting group](#)" on [page 52](#) explains how to activate scanning.

Standard and background scanning

The two types of scanning that may be available on your radio are standard scanning, and background scanning. Background scan can only be activated by using a function key programmed for background scan. It differs from standard scanning in that the channel that was selected when background scan was activated is also included as a scan-group member.

Making a call while scanning

If you wish to make a call while your radio is scanning:

- 1 Lift the microphone off the microphone clip.
- 2 Press the PTT key to transmit. If the orange LED is flashing, or background scan is active, your radio will now call the currently selected channel.
- 3 If standard scan is active and there has been no recent activity on the channel (the orange LED is glowing rather than flashing), then the channel that is called depends on the way your radio has been programmed. The possible options are:
 - your radio calls a predetermined channel e.g. your dispatcher,

- your radio calls the channel where activity was last detected, or
 - your radio calls the last free channel.
- 4 When the called party responds, proceed with your conversation.

Suspending a channel from a scanning group

If a member channel of a scan group is busy for a long time and you do not wish to hear the conversation, you may be able to use the function key programmed for nuisance delete to temporarily delete it from the scan group.

When the scan group is next selected, or after the radio has been turned off and then on, the deleted channel is again part of the scan group.

Alternatively, the function key programmed for scanning may be programmed so that a short key press turns on scanning, and a long key press activates nuisance delete.

- Press and hold the function key programmed for scanning to remove the current channel from the scanning group.

If the operation has been successful, the message **Channel deleted from group** appears on the display.

Adding or deleting member channels of a group

Your radio may be programmed so you can add or delete channels in a voting or scanning group. Changes made are permanent, and will remain after restarting the radio.

- 1 Select the group. See "[Selecting a scan or voting group](#)" on page 52.
- 2 Press **Edit**.

If there is no edit option for the left selection key, the group cannot be changed.

Alternatively, you may be able to edit groups by pressing **Menu** and selecting **Advanced > Program groups**, then select the group you wish to edit.

- 3 In the **Edit group** menu, choose **Add channel** or **Delete channel**.
- 4 Press **Select**.
- 5 Press the scroll keys to select the channel that you want to add or delete.
- 6 Press **OK**.

If successful, the message **Channel added** or **Channel deleted** appears.



To check the new group details, press **Back** and select the **Group members** menu option.

Changing a group's transmit channel

You may be able to change the transmit channel of a standard scanning group. The transmit channel is identified by the T_x icon.

- 1 Select the group. See "[Selecting a scan or voting group](#)" on page 52.
- 2 Press **Edit**.

If there is no edit option for the left selection key, the group cannot be changed.

Alternatively, you may be able to edit groups by pressing **Menu** and selecting **Advanced > Program groups**, then select the group you wish to edit.

- 3 In the **Edit group** menu, choose **Change tx**.
- 4 Press **Select**.
- 5 Press the scroll keys to select the new transmit channel.
- 6 Press **OK**.

If successful, the message **Tx channel changed** appears.



To check the new group details, press **Back** and select the **Group members** menu option. The new transmit channel has the T_x icon next to it.

Changing a group's first or second priority channel

You may be able to change the priority channels of a scanning group. Priority channels are scanned more frequently than other channels in the group. If valid activity is found on another channel, the radio continues to scan the priority channel or channels at regular intervals. The first priority channel is identified by the P_1 icon, and the second priority channel is identified by the P_2 icon.

1 Select the group. See "[Selecting a scan or voting group](#)" on page 52.

2 Press **Edit**.

If there is no edit option for the left selection key, the group cannot be changed.

Alternatively, you may be able to edit groups by pressing **Menu** and selecting **Advanced > Program groups**, then select the group you wish to edit.

3 In the **Edit group** menu, choose **Change P1** or **Change P2**.

4 Press **Select**.

5 Press the scroll keys to select the new priority channel.

6 Press **OK**.

If successful, the message **P1 channel changed** or **P2 channel changed** appears.



To check the new group details, press **Back** and select the **Group members** menu option. The new priority channel has the P_1 or P_2 icon next to it.

Icon and messages that may appear when changing group details

The following icons may appear when viewing group membership details, adding or deleting channels from a group, or changing a group's transmit or priority channels.



Icon	Meaning
T_X	This channel is used to transmit on when there has been no recent activity. You cannot delete this channel (it will not appear under Delete channel).
P_1	This channel is the group's first priority channel. You cannot delete this channel (it will not appear under Delete channel).
P_2	This channel is the group's second priority channel. You cannot delete this channel (it will not appear under Delete channel).
+	There is more than one instance of this channel in the group (the channel will be scanned more often). If you delete this channel, the radio will attempt to delete all instances of the channel.

The following messages may appear when using nuisance delete to temporarily delete a channel from a group, when adding or deleting channels from a group, or changing a group's transmit or priority channels.

Message	Meaning
Scanning not on	You cannot use nuisance delete to temporarily delete a channel from a group, as there is no group currently selected.
No channel captured	You cannot use nuisance delete to temporarily delete a channel from the group, as there is no channel currently captured (the orange LED is glowing and not flashing).
Not enough channels in group	You cannot use nuisance delete to temporarily delete the channel from the group, as the captured channel is the last remaining group member.
Cannot delete channel	You cannot use nuisance delete to temporarily delete the channel from the group. The captured channel may be the selected channel in a background scan group.
Cannot delete priority chan	You cannot use nuisance delete to temporarily delete the channel from the group, as the captured channel is a priority channel.
Only two channels in group	You cannot delete a channel from the group, as there would be only one group member left.
No items in list	The action you are attempting is not allowed. Either: <ul style="list-style-type: none"> ■ the group does not have a preset transmit channel or priority channels programmed, or ■ you have added all the channels in the zone to the current group.
Group full	You cannot add any more channels to the group, as the maximum number of members (50) has been reached.

6 Operating in trunked mode

This section explains how your radio operates on a DMR (digital), MPT (analog) or dual-mode trunked network.

-  These features are controlled by software licenses (SFE) and may not be available with your radio.
-  Your radio must have trunking functionality programmed before it can operate in DMR or MPT trunked mode.

This section covers:

- [Checking that your network is available](#)
- [Changing your network](#)
- [Making a call using the address book](#)
- [Making a preset call](#)
- [About trunked zones and workgroups](#)
- [About emergency operation](#)
- [Dialing a PABX number](#)
- [Dialing a PSTN number](#)
- [Receiving a call](#)
- [Re-establishing a call](#)
- [Checking the queue](#)
- [About status messages](#)
- [About trunked text messages](#)
- [Placing the radio in do-not-disturb mode](#)
- [Switching to conventional channels or conventional groups](#)

Checking that your network is available

Check that the orange LED is glowing and the network icon 'F' appears in the display. These are the indications that your radio has access to a trunked network.

If the network icon is flashing and **No service** appears on the display, your radio is attempting to access the trunked network. If this icon remains flashing, your radio may be out of the network coverage area.

If **Limited service** appears on the display, one of the network sites or the connection between the network sites has been interrupted. You can still make calls to radios covered by the same site but not to radios on other sites.

Changing your network

Your radio may be programmed to operate in up to four completely separate trunking networks, either DMR (digital), MPT (analog) or both (dual mode). You may wish to change networks because you are out of the network coverage area, or you need to have access to another trunking network.

To change your radio's operating network, you may be able to either use the Main menu or dial the new network using the alphanumeric keys.

 Changing your radio's workgroup may also change the network in which you are operating. See ["Selecting a workgroup" on page 94.](#)

Using the Main menu

- 1 Press **Menu** and select **Change network**.

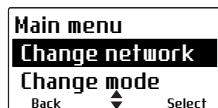

- 2 In the **Change network** menu, scroll through the list of networks until the network you want appears.
- 3 Press **Select**.

The radio will restart and display the name of the new network.

Dialing a new network



This feature is only available for radios with alphanumeric keys.

- 1 Dial ***700#** to display the name of the current trunked network.
- 2 Dial ***70n#** to change to a new network, where **n** is the number of the new network (1 to 4).

The radio will restart and display name of the new network.

Making a call using the address book

The **Address book** menu programmed for your radio may contain calls to other radios, to PABX extensions or to PSTN numbers.

Address book calls may also be used to send status information, such as “at lunch” or “on site”. For more information, see ["Using the address book" on page 41](#).

- 1 Press **Menu** and select **Address book**.



(Depending on how your radio is programmed, you may be able to use the scroll keys, left selection key or a function key to select the **Address book** menu.)

- 2 In the **Address book** menu, scroll through the list of calls until the call you want appears.
- 3 Press **Options** and **Call**, or press PTT.

The call details appear on the display, the red LED glows, and **↔** appears on the display.

Making a preset call

The preset calls programmed for your radio may be to other radios, to PABX extensions or to PSTN numbers.

- 1 Press **Menu** and select **Preset calls**.



(Depending on how your radio is programmed, you may be able to use a function key, or left selection key to select the **Preset calls** menu.)

- 2 In the **Preset calls** menu, scroll through the list of calls until the call you want appears, then press **Send**.

While the call is being setup, you can cancel the call by pressing **Clear**.

Dialing a preset call



This feature is only available for radios with alphanumeric keys.

It may be possible to dial preset calls, if preset calls are programmed for your radio and you know the number associated with the preset call.

- 1 Dial **p**, where **p** is the number of the preset call.

If your preset call number is the same as a call to another radio, then you need to dial a leading **0**. For example, dial **23#** to call radio 23 and dial **023#** for preset call number 23.



- 2 Press **Send** or the **#** or PTT key.

While the call is being setup, you can cancel the call by pressing **Cancel**.

About trunked zones and workgroups

Trunked zones and workgroups are used to manage the calls on the trunked system. Zones, if used, typically define geographic areas (towns, suburbs or counties), or branches of an organization. Workgroups span multiple zones, and typically define functions, work areas or job roles.

When your radio belongs to a workgroup, it is said to be 'subscribed', and you receive all calls directed to that group of users. A group's members are dynamic, in that a group only contains radios that are currently registered on the system and subscribed to the same group.

-  Your radio may be programmed to use different names for a 'zone' and 'workgroup'. For example, 'district' or 'area' may be used in place of zone, and 'role' or 'group' may be used in place of workgroup.

Selecting a zone

- 1 Press **Menu** and select **Set zone**.

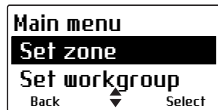

(Depending on how your radio is programmed, you may be able to use the scroll keys or left selection key to select a zone.)

- 2 In the **Set zone** menu, scroll through the list of zones until the zone you want appears.
- 3 Press **Select**.
- 4 Check that orange LED is glowing and the network icon  appears on the display.

Automatic zone selection

Your radio may be configured to change zones automatically based on your location.

Selecting a zone manually as described above will end automatic mode, and the manual mode icon  will appear on the display.

Your radio may be configured to use a timer or a function key to return to automatic mode.

Selecting a workgroup

- 1 Press **Menu** and select **Set workgroup**.



(Depending on how your radio is programmed, you may be able to use the scroll keys or left selection key to select a workgroup.)

- 2 In the **Set workgroup** menu, scroll through the list of workgroups until the workgroup you want appears.

- 3 Press **Select**.
- 4 Check that orange LED is glowing and the network icon  appears on the display.

Making a call to a workgroup

Different types of calls may be associated with your workgroups. These calls can be any types of calls.

To make a call to a workgroup:

- 1 Select the required zone. See "[Selecting a zone](#)" on page 94.
- 2 Select the required workgroup. See "[Selecting a workgroup](#)" on page 94.
- 3 Press the PTT key, and a call to that workgroup is made.

Dialing a workgroup call



This feature is only available for radios with alphanumeric keys.

It may be possible to dial workgroup calls, if you know the number associated with the workgroup.

- 1 Dial **w**, where **w** is the number of the workgroup.

If your workgroup call number is the same as a call to another radio, then you need to dial a leading **0**. For example, dial **23#** to call radio 23 and dial **023#** for workgroup call number 23.

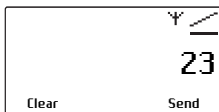

- 2 Press **Send** or the # or PTT key.

While the call is being setup, you can cancel the call by pressing **Cancel**.

Selecting the homegroup

Your 'homegroup' is the workgroup in which your radio usually operates. To return to your homegroup at any time, you may be able to use the main menu, or use a function key.

Using the Main menu

- 1 Press **Menu** and select **Go to homegroup**.



- 2 Press **Select**, and the radio now shows your homegroup in the default display.

Using function keys

You may be able to use function keys to go to your homegroup or to toggle between your homegroup, and the currently selected zone and workgroup.

- Press the function key programmed to go to your homegroup.

The radio now shows your homegroup on the default display.

- Press the function key programmed to toggle between your homegroup and the currently selected zone and workgroup.

The radio now shows your homegroup on the default display, along with the homegroup icon .



The homegroup icon only appears if you use a function key to toggle between your homegroup and the currently selected zone and workgroup.

Scanning workgroups

The 'My Workgroups' list comprises the current workgroup, the homegroup, and other programmed groups. When scanning is active, the radio will receive activity from any subscribed groups in the My Workgroups list.

To activate scanning:

- 1 Press **Menu** and select **Scanning**.



(Depending on how your radio is programmed, you may be able to use a function key to turn scanning on or off.)

- 2 Scroll to **On** (or **Off**) and press **Select**.

About emergency operation

In an emergency you may be able to summon help by sending an emergency call. After making the call, your radio may be programmed to enter emergency mode. While emergency mode is active, your radio may cycle between receive and transmit, so that your dispatcher or the called party can hear any activity near your radio.

On most networks, an emergency call takes precedence over other call types, and existing calls are cleared down so that the emergency call can proceed.

To make an emergency call from your radio, you may be able to either:

- use a function key programmed for emergency mode
- make an emergency call using
 - the address book (see ["Making a call using the address book" on page 91](#))

- a workgroup (see ["Making a call to a workgroup" on page 95](#))
- a preset (see ["Making a preset call" on page 92](#))
- dial the emergency call using the alphanumeric keys

Dialing an emergency call



Dialing is only available for radios with alphanumeric keys.

- 1 Dial ***9**.
- 2 Press **Send** or the **#** or PTT key.

An emergency call is now sent to the emergency location that has been programmed for your radio.



If you wish to send an emergency call to another radio, you may be able to dial ***9*n** then press the **#** or PTT key. In this case, **n** is the radio unit number you wish to send the emergency call to and may be a two- or three-digit number.

Activating emergency mode

You can activate emergency mode using a function key programmed for emergency mode. Alternatively, you may be able to activate emergency mode using a hidden switch or panic button. Once emergency mode is activated, your radio makes an emergency call to your dispatcher or some other predetermined location. The radio then enters emergency mode.

While emergency mode is active, your radio may cycle between receive and transmit, so that your dispatcher can hear any activity near the radio.

Cancelling emergency mode

Reset the radio to normal operation at any time by turning the radio off and then on.

- ① Emergency mode may be programmed to end after a fixed period of time. In this case, there is no need to turn the radio off and then on in order to return the radio to normal operation.

Dialing a PABX number

- ① Dialing is only available for radios with alphanumeric keys.

To dial a PABX extension:

- 1 Dial **n**, where **n** is the PABX extension you wish to call.
- 2 Press **Send** or the **#** or PTT key.

The call details appear on the display. While the call is being setup, you can cancel the call by pressing **Cancel**.

Dialing a PSTN number

- ① Dialing is only available for radios with alphanumeric keys.

To dial a PSTN number:

- 1 Dial **0n**, where **n** is the PSTN number you wish to call.



- ① The numbers you dial before the 0 depend on the way your network operates.

- 2 Press **Send** or the **#** or PTT key.

The call details appear on the display. While the call is being setup, you can cancel the call by pressing **Cancel**.

Receiving a call

When you receive a call, your radio may:

- automatically accept the call. The  icon appears on the display. The radio may also be programmed to beep or ring. In this case, the caller will usually talk first.
- ring like a telephone. Press **Answer** to accept the call. The radio gives a beep and the  icon appears in the display. You may also be able to accept the call if you press the PTT key or lift the microphone off the microphone clip. In this case, you will usually talk first.

Once the  icon appears, you can proceed with the call, as follows:

- 1 Hold the microphone about 2 inches (5 cm) from your mouth.
- 2 Press and hold the PTT key to transmit.
- 3 Speak clearly into the microphone and release the PTT key when you have finished talking.

While you are transmitting, the red LED glows and  appears in the display.

- 4 End the call by placing your microphone back onto its hook or by pressing **End**. The network may also end the call if neither you nor the other party transmits for a predetermined time or if your call time limit is exceeded.

Transmit timer

Your radio may have a transmit timer that limits the amount of time you can transmit continuously.

When the transmit timer is about to expire, the message **Transmit timeout imminent** appears in the display, the red LED flashes, and the radio gives three beeps.

If the transmit timer times out, the call clears down.

Call time limit

In trunked mode, the length of your call may be limited by the network or by your radio. Your radio may be programmed to display the time remaining for your call.

Re-establishing a call

The last number recall, unanswered call and callback functions may allow you to re-establish calls using the PTT key.

Last number recall

When an outgoing call has ended, the message **Last call to** and the called unit's identity may appear on the display.

To make a call to that person again, briefly press the PTT key.

Unanswered call

When an incoming call is missed, the message **Missed call** and the caller's identity may appear in the display.

To return the call, briefly press the PTT key.

Callback

When an incoming call has been ended, the message **Last call from** and the caller's identity may appear in the display.

To make a call to that person, briefly press the PTT key.

Checking the queue

If you have missed an incoming call, or if you received a status message or text message, it may be stored in the queue. The queue icon  appears and information about the missed call or message may be shown on the display.

The queue can be programmed to store multiple calls or messages or just the last call or message.

In the example below, a status message was received from Car 1. This is the first of three calls or messages stored in the queue.

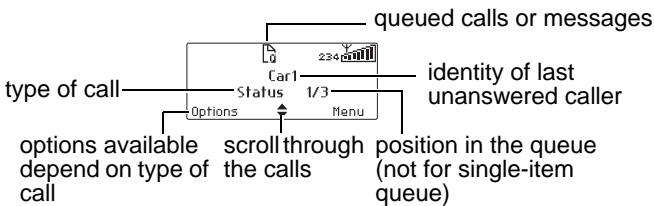

Press **Options** to either view, reply, call back, look at the entry details, or delete the entry.

Your radio may be also programmed to automatically view the full status message or text message on receipt.

If there are calls or messages in the queue, the radio may emit a warble tone for a period of time.

The notification starts again when the radio is restarted or another call is received.

Accessing the queue

- 1 If the call or message information is not shown already, press **Menu > Call queue**.

(Depending on how your radio is programmed, you may be able to press a function key to access the queue.)

2 Use the scroll keys to move through the calls or messages in the queue until the item you want appears.

3 Press **Options**.

The options available depend on the type of call it is. For a voice call, select **Call** to return the call.

For a status message or a text message, select **View** to read the message, **Reply** to reply, or **Call** to return the call.

Your radio may be also programmed to automatically view the full status message or text message on receipt.

You can also delete the selected call or messages, or delete all queued calls and messages.

Changing your queue settings

Your radio may be programmed so that you are able to change queuing between “unanswered” and “full”.

In “unanswered” queuing, incoming individual voice calls are only queued if unanswered.

In “full” queuing, incoming individual voice calls are queued immediately and you don’t get an option to answer the call.

In both cases, all status and text messages are queued immediately.

If your radio has alphanumeric keys, you may be able to change your call queuing setting using the keypad.

To activate “full” queuing:

- press **Menu** and select **Radio settings > Call settings > Call queuing** and choose **On**
- press the function key programmed for Call queuing, or
- dial ***48** then press the **#** or PTT key

The message **Call queuing activated** appears.

To change call queuing to “unanswered” queuing:

- press **Menu** and select **Radio settings > Call settings > Call queuing** and choose **Off**
- press the function key programmed for Call queuing, or
- dial **#48** then press the **#** or PTT key

The message **Call queuing deactivated** appears.

About status messages

A status message is sent to another party to indicate your current activity or location, such as “en route” or “at lunch”. If the radio receiving your message has been programmed with the same status messages, it will decode and display your message. If you receive a status message, the message is automatically queued, since a response is not expected.

Selecting a status message

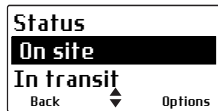

- 1 Press **Menu** and select **Send > Status**.
- 2 In the **Status** menu, scroll through the list of status messages until the message you want appears.



Sending a status message

- 1 When you have chosen a message, press **Send** and the **Send to** menu opens.
- 2 In the **Send to** menu, scroll through the list of options until the choice you want appears.



-  If your radio has alphanumeric keys, you can choose the option **Dialed**, then dial the number of the party you wish to call.
 -  If you select **Address book** or **Preset**, scroll to the entry you want and press **Select**.
- 3 Press **Select**.

The call details appear on the display. While the call is being setup, you can cancel the call by pressing **Cancel**.

Dialing a status message

If your radio has alphanumeric keys, the status messages programmed for your radio can be dialed. To dial the message, you need to know the number associated with the status message.

To dial a status message:

- 1 Dial ***0s*n**, where **s** is the number of the status message and **n** is the radio unit number you wish to send the message to.
- 2 Alternatively, dial ***0s*p**, where **p** is the number of a preset call or workgroup. See ["Dialing a preset call" on page 92](#) or ["Dialing a workgroup call" on page 95](#) for more information.
- 3 Press **Send** or the **#** or PTT key.

The call details appear on the display. While the call is being setup, you can cancel the call by pressing **Cancel**.

Receiving a status message

If the radio is programmed for call queuing, incoming status messages are added to the queue. For more information, see ["Checking the queue" on page 103](#).

Press **Options** and select whether to reply, call or delete.

Your radio may be programmed to automatically view status messages on receipt.

If the radio is not programmed for call queuing, incoming status messages will not be stored or displayed.

About trunked text messages

Your radio may be programmed so that you can send text messages. The three options for creating text messages are selecting a preset text message, editing a draft text message, or creating a new text message.











 To either edit or enter a text message, your radio must have alphanumeric keys.

Using the alphanumeric keys to enter text

When the alphanumeric keys are used to enter a text message, they have special functions.

- Use the # key to select the type of text entry: upper and lower case characters (**ABC**, **abc**), initial capitals (**Abc**), or numbers (**123**).
- Use the left selection key (**Clear**) to delete a character from the display.
- Use the scroll keys to move through a message.

Repeated presses of these keys will give you the characters shown in the following table.

Key	Characters	Key	Characters
	. , ? ! - / 1		P Q R S 7
	A B C 2		T U V 8
	D E F 3		W X Y Z 9
	G H I 4		space 0
	J K L 5		
	M N O 6		

In the example below, a preset text message has been selected, and is being edited.

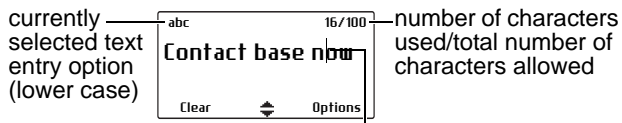

cursor: shows current point of text entry

Sending a preset text message

- 1 Press **Menu** and select **Send > Text message > Preset message**.



In the **Preset message** menu, a short label representing each message is displayed.



- 2 Scroll through the list of preset message labels until the one you want appears.

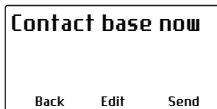

- 3 Press **Select**, and the text message you have chosen is now displayed.



- 4 Press **Send** to send the message, or **Edit** to change the message.

Pressing  will place the cursor at the start of the message. Pressing  will place the cursor at the end of the message. When the message is complete, press **Options** and select **Send**.

Creating a new text message

- 1 Press **Menu** and select **Send > Text message > New message**.
- 2 Use the alphanumeric keys to add characters and the **Clear** key to delete them. Use the scroll keys to move through the characters.



- 3 When the message is complete, press **Options** and select **Send**.

If you decide to cancel out of editing a text message or receive a call while editing, the current draft will be saved and is available for editing later.

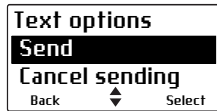

Sending a text message

- 1 When you have finished editing the message, press **Options** and the **Text options** menu opens.



- 2 In the **Text options** menu, select **Send**.
- 3 In the **Send to** menu, scroll through the list of options until the choice you want appears.



-  If your radio has alphanumeric keys, you can choose the option **Dialed**, then dial the number of the party you wish to call.
 -  If you select **Address book** or **Preset**, scroll to the entry you want and press **Select**.
- 4 Press **Select**.

The call details appear on the display. While the call is being setup, you can cancel the call by pressing **Cancel**.

Editing a draft text message

- 1 Press **Menu** and select **Send > Text message > Edit message**.

The last sent or edited text message will appear.

- 2 Use the scroll keys to move through the characters. Use the alphanumeric keys to add characters and the **Clear** key to delete them.



- 3 When the message is complete, press **Options** and select **Send**.

If you decide to cancel out of editing a text message or receive a call while editing, the current draft will be saved and is available for editing later.

Receiving a text message

If the radio is programmed for call queuing, incoming text messages are added to the queue. For more information, see ["Checking the queue" on page 103](#).

Press **Options** and select whether to reply, call or delete.

Your radio may be programmed to automatically view text messages on receipt.

If the radio is not programmed for call queuing, incoming text messages will not be stored or displayed.

Placing the radio in do-not-disturb mode

If you do not want calls for a while, you can place the radio in do-not-disturb mode, so that incoming calls can be ignored. You can make outgoing calls in the usual way.



While do-not-disturb mode is active, incoming calls cannot be stored in the call queue.

Using a function key

- 1 Press the function key programmed for do not disturb, to activate the do-not-disturb function.

The message **Do not disturb activated** appears on the display. Your radio will now ignore all incoming calls.

- 2 To deactivate the do-not-disturb function, press the do-not-disturb function key again.

The message **Do not disturb deactivated** appears on the display.

Using the Main menu

- 1 Press **Menu** and select **Radio Settings > Call Settings > Do not disturb**.
- 2 In the **Do not disturb** menu, choose **On**.
- 3 Press **Select**.

The message **Do not disturb activated** appears on the display. Your radio will now ignore all incoming calls.

Switching to conventional channels or conventional groups

You may be able to dial conventional channels or groups, using **101** to **110**. The channels or groups called using these numbers are programmed for your radio.

To call a conventional channel or group:

- 1 Dial the number for the channel or group you wish to call.
- 2 Press **Send** or the **#** or PTT key.

Your radio switches to the conventional channel programmed for that number.

7 Dialing calls in trunked mode

If your radio has alphanumeric keys, you can make dialed calls from your radio. The numbers you dial and dialing features available depend on the way your radio is programmed and the way your network operates. Contact your radio provider for further assistance.

This section covers:

- [MPT 1343 dialing](#)
- [DMR dialing](#)
- [Nokia ANN fleet calls](#)
- [Accessing common trunking functions](#)

MPT 1343 dialing

If your MPT or DMR trunked network uses the MPT 1343 dialing scheme, your radio's unique number on the network consists of:

- a three-digit prefix,
- a four-digit fleet number, and
- a two- or three-digit radio unit number.

You may also be part of a group, with a two- or three-digit group number.

Finding your radio's MPT number

To find your radio's full MPT number:

- 1 Dial ***700**.
- 2 Press the **#** or PTT key.

The name associated with your network and your radio's full MPT number appears.

The number is in the form:

Prefix 300	Fleet 3078	Radio unit number 234
---------------	---------------	--------------------------

MPT 1343 dialed calls

The following table summarizes the way you dial calls to other radios and groups of radios using the MPT 1343 dialing scheme, and gives an example of each type of call.



In the following examples, the final # may be replaced by a short press of the PTT key.

Call to	Dialing code and example
Radio 23 in the same fleet as you	Radio unit number 23 #
Radio 234 in the same fleet as you	Radio unit number 234 #
Radio 23 in fleet 3078 with the same prefix as you	Fleet 3078 Radio unit number 23 #
Radio 234 in fleet 3078 with the same prefix as you	Fleet 3078 Radio unit number 234 #
Radio 234 in fleet 3078 with a different prefix to you (300)	Prefix 300 Fleet 3078 Radio unit number 234 #
Group 92 in the same fleet as you	Group 92 #
Group 923 in the same fleet as you	Group 923 #

DMR dialing

If your trunked network uses the DMR dialing scheme, your radio's unique number on the network consists of:

- a three-digit prefix
- a two-digit fleet number, and
- a three-digit unit number

You may also be part of a group, with a three-digit group number.

Finding your radio's DMR number

To find your radio's full DMR number:

- 1 Dial ***700**.
- 2 Press the **#** or PTT key.

The name associated with your network and your radio's full DMR number appears.

The number is in the form:

Prefix 330	Fleet 78	Radio unit number 542
---------------	-------------	--------------------------

DMR dialed calls

The following table summarizes the way you dial calls to other radios and groups of radios using the DMR dialing scheme, and gives an example of each type of call.



In the following examples, the final # may be replaced by a short press of the PTT key.

Call to	Dialing code and example
Radio 332 in the same fleet as you	Radio unit number 332 #
Radio 521 in the same fleet as you	Radio unit number 521 #
Radio 332 in fleet 78 with the same prefix as you	Fleet 78 Radio unit number 332 #
Radio 521 in fleet 78 with the same prefix as you	Fleet 78 Radio unit number 521 #
Radio 332 in fleet 78 with a different prefix to you (350)	Prefix 350 Fleet 78 Radio unit number 332 #
Group 990 in the same fleet as you	Group 990 #
Group 923 in the same fleet as you	Group 923 #

Nokia ANN fleet calls

If your trunked network uses Nokia ANN dialing, the numbers you dial depend on your fleet size. Fleets are defined as either large, small or mini. Your radio's unique number on the network consists of:

- a lead number **7**, **8** or **9**, depending on the fleet size,
- a zero-, one-, two- or three-digit prefix,
- a one- or two-digit fleet number, and
- a two- or three-digit radio unit number.

See your radio provider or network administrator for Nokia ANN call details.

Finding your radio's Nokia ANN number

To find your radio's full Nokia ANN number:

- 1** Dial ***700**.
- 2** Press the **#** or PTT key.

The name associated with your network and your radio's full Nokia ANN number appears.

The number is in the form:

Lead 7	Prefix 34	Fleet 2	Radio unit number 209
-----------	--------------	------------	--------------------------

Nokia ANN dialed calls

The following table summarizes the way you dial calls to other radios and gives an example of each type of call.

 In the following examples, the final # may be replaced by a short press of the PTT key.

Call to	Dialing code and example
Radio 23 in the same fleet as you	Radio unit number 23 #
Group 923 in the same fleet as you	Group 923 #
Large fleet:	
Call to radio 234 in fleet 1 with the same prefix as you	Lead 7 Fleet 1 Radio unit number 234 #
Call to radio 235 in fleet 2 with a different prefix to you (32)	Lead 7 Prefix 32 Fleet 2 Radio unit number 235 #
Call to radio 236 in fleet 2 with the same lead and prefix ¹	Fleet 2 Radio unit number 236 #
Small fleet:	
Call to radio 23 in fleet 51 with the same prefix as you	Lead 7 Fleet 51 Radio unit number 23 #
Call to radio 24 in fleet 52 with a different prefix to you (126)	Lead 7 Prefix 126 Fleet 52 Radio unit number 24 #
Call to radio 25 in fleet 53 with the same lead and prefix ¹	Fleet 53 Radio unit number 25 #
Mini fleet:	
Call to radio 23 in fleet 80 with the same prefix as you	Lead 7, 8 or 9 Fleet 80 Radio unit number 23 #
Call to radio 24 in fleet 81 with a different prefix to you (3)	Lead 7, 8 or 9 Prefix 3 Fleet 81 Radio unit number 24 #
Call to radio 25 in fleet 81 with the same lead and prefix ¹	Fleet 81 Radio unit number 25 #

1. If 4-digit-dialing is configured in the programming application.

Accessing common trunking functions

The following tables explain how you can access special MPT or DMR trunking functions using the * and # keys. The availability of these functions is dependant on the way your radio is programmed and the way your network operates.



In the following examples, the final # may be replaced by a short press of the PTT key.

*... # functions

Dialing code	Functions	Example
#	Accept an incoming FOACSU call	
*#	Clear call or displayed item, or decline an incoming FOACSU call	
*0#	Request base dispatcher to call you back	
#0#	Cancel request	
*0*n#	Request another dispatcher to call you back	*0*234#
#0*n#	Cancel request	#0*234#
*0s*n#	Status call to radio n (s = status 0 to 31, MPT, or 0 to 127, DMR)	*015*23#
*0s#	Status call to dispatcher	*015#
g#	Conference call to group g	92#
*11*g#	Broadcast call to group g	*11*92#
*41*n#	Divert own calls to radio n	*41*23#
#41#	Cancel divert	
*41*0n#	Divert own calls to PSTN n	*41*03456798#
#41#	Cancel divert	
*44*n*m# ¹	Divert 3rd party calls n to m	*44*23*21#
44*n# ¹	Cancel divert of 3rd party calls	#44*23#
*441*m#	Divert of speech calls to m	*441*21#
#441#	Cancel divert of speech calls	#441#
*442*m#	Divert of packet data calls to m	*442*21#
#442#	Cancel divert of packet data calls	#442#

***... # functions**

Dialing code	Functions	Example
*451#	Cancel incoming call diversions (speech only)	
*452#	Cancel incoming call diversions (packet data only)	
*453#²	Cancel incoming call diversions (SDM only)	
*454#²	Cancel incoming call diversions (status only)	
*46#³	Toggle encryption	
*461#³	Turn encryption off	
*462#³	Turn encryption on	
*47#³	Display the current network and your full radio number	
*48#	Queue incoming calls	
#48#	Cancel queue	
*49#	Do not disturb	
#49#	Cancel do not disturb	
*491#	DMR: Do not disturb (SDM calls) MPT: Do not disturb (voice calls only)	
#491#	DMR: Cancel do not disturb (SDM calls) MPT: Cancel do not disturb (voice calls only)	
*492#	Do not disturb—data calls only	
#492#	Cancel do not disturb—data calls only	
*50*n#¹	Select channel n (site-select diagnostic function, enabled during programming)	
*50*xnnnnn#²	Select channel xnnnnn , where x is the logical channel and nnnnn is the physical channel (site-select diagnostic function, enabled during programming)	
#50#	Resume normal channel hunting (site-select diagnostic function, enabled during programming)	
*700#	Display the current network and your full radio number	
*70n#	Change to network n (1 to 4)	*702#

***... # functions**

Dialing code	Functions	Example
*8*n# ⁴	Priority call (DMR: highest, MPT: high) to radio n	*8*23#
*8*g# ⁴	Priority conference call (DMR: highest, MPT: high) to group g	*8*923#
*81*n# ⁴	Priority call (DMR: highest, MPT: high) to radio n	*81*23#
*81*g# ⁴	Priority conference call (DMR: highest, MPT: high) to group g	*81*923#
*82*n# ⁴	Priority call (DMR: high) to radio n	*82*23#
*82*g# ⁴	Priority conference call (DMR: high) to group g	*82*923#
*83*n# ⁴	Priority call (DMR: medium) to radio n	*83*23#
*83*g# ⁴	Priority conference call (DMR: medium) to group g	*83*923#
*9*n#	Emergency call to radio n	*9*23#
*9*g#	Emergency conference call to group g	*9*923#
**n# ¹	Abbreviated dialed codes (1-49)	**3#

1. MPT only.
2. DMR only.
3. DMR dialing scheme only
4. DMR has three priority levels and MPT has one priority level.
*8 and *81 are interchangeable. Dialing *82 or *83 in MPT mode has the same effect as dialing *8 or *81.

8 Location services

This section explains how to use the location services that may be available on your radio.

 This feature is controlled by a software license (SFE) and may not be available with your radio.

This section covers:

- [About location information](#)
- [About location statuses](#)
- [Viewing location information](#)

About location information

If your radio is connected to the receiver of a satellite navigation system, you can view location information such as latitude and longitude, true course, speed, and coordinated universal time. Your radio can also display universal transverse mercator (UTM) information such as the UTM zone, and northing and easting coordinates.

Your radio may also be set up to send and log location information.

About location statuses

In the **Own location** screen, location status information appears at the top right of the display.

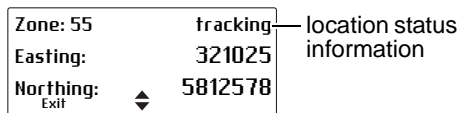

Status information shown on a hand-held control head is shown in brackets [].

- **tracking [Trk]**: the receiver is displaying up-to-date satellite information.
- **stored**: the receiver is having trouble connecting to satellites and the radio is displaying stored information that may not be current.
- **lost cnx [no cnx]**: the radio has lost serial communications with the receiver.

Viewing location information

- 1 Press **Menu** and select **Location Svs > Own location**.

(Depending on how your radio is programmed, you may be able to press a function key to access the **Own location** menu.)

Location information is now shown in the display, if it is available.



Your radio may be programmed to show any of these displays.

- 2 Use the scroll keys to scroll through the **Own location** displays.

Zone: 59	tracking
Easting:	321025
Northing:	5812578
Exit	◆

- Zone: UTM zone number
- Easting and Northing: Raw Universal Transverse Mercator (UTM) Cartesian coordinates

Location	tracking
S	43°29'00.0"
E	172°33'05.0"
Exit	◆

- Latitude and longitude in degrees, minutes and decimal seconds

Location	tracking
Course: 010°	
Speed: 045 km/h	
Exit	◆

- The radio's current course and speed

Location	tracking
UTC time:	23:36:20
Exit	◆

- UTC: Coordinated Universal Time 24 hour clock

- 3 Press **Exit** to exit the location display.

In certain situations, your radio may automatically exit the location display.

9 Loneworker monitoring

Loneworker monitoring is a safety feature for people who work alone. Loneworker monitoring may be programmed to be on or off at all times, or can be switched on and off by the user using a programmed function key or the menu.

A loneworker alarm is activated, if there has been no user activity for a predetermined time.

When the predetermined time has expired, an audible warning is given and you have a predetermined time to respond to the loneworker situation.

If you are unable to respond, the radio either enters emergency mode or (in trunked mode) sends a status update to a predetermined person or talkgroup.

Activating loneworker monitoring

- 1 Press **Menu** and select **Radio Settings > Extra features > Loneworker**. (Depending on how your radio is programmed, you may be able to press a function key to turn loneworker monitoring on and off.)



- 2 In the **Loneworker** menu, choose **On**.

A vertical scroll bar on the right-hand side of the display indicates the remaining activity timeout.

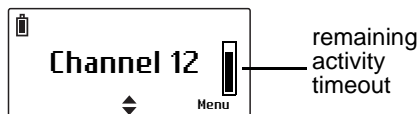

Responding to a loneworker alarm

If you hear a beep to indicate that the radio is expecting a response from you to acknowledge that you are safe. The message **Loneworker awaiting** and a horizontal scroll bar appear indicating the remaining time until an emergency action is triggered.

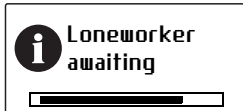

- Press any key.

Otherwise the radio will activate emergency mode or (in trunked mode) send a status update.

10 Encryption

This section describes how to use encryption to make your communications completely private.



This feature is controlled by a software license (SFE) and may not be available with your radio.

This section covers:

- [About encryption](#)
- [Encrypting calls](#)
- [Making an encrypted call](#)
- [Receiving an encrypted call](#)
- [Removing encryption keys from the radio](#)

About encryption

The encryption feature is available for digital and dual-mode networks only.

To make communications with other users on your system completely private, your radio may be able to encrypt outgoing calls, using a confidential encryption key. The radio receiving your call must have the same encryption key installed before it can hear your encrypted call.

Encrypting calls

Your radio may be able to turn encryption on and off. While encryption is on, your outgoing calls are encrypted on networks programmed for encryption, and the encryption icon  remains in the display.

This setting only affects outgoing calls. Incoming calls will still be decoded by your radio so long as the key required to decode the call is stored in your radio.

To turn encryption on or off:

- 1 Press **Menu** and select **Security > Encryption**. (Depending on how your radio is programmed, you may be able to press a function key to turn encryption on and off.)
- 2 Scroll to **On** (or **Off**) and press **Select**.

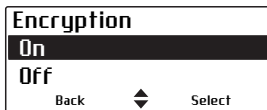

The message **Encryption activated** (or **deactivated**) appears in the display.

-  If you attempt to transmit with encryption turned on but don't have any keys loaded, the message **Key fail** appears.

Making an encrypted call

- 1 Select the network you wish to operate on.
- 2 Check that encryption is on ( is showing in the display).
- 3 Press and hold the PTT key to transmit.

While you are transmitting, the red LED glows and  appears in the display.



If you transmit or receive an unencrypted call on an encrypted network, the  disappears and your radio may be programmed to issue an audible alert.

Receiving an encrypted call

When you receive an encrypted call, your radio unmutes and you can hear clear speech, so long as the key required to decode the call is stored in your radio.

If the key required to decode the call is not stored in your radio, then your radio remains muted and the message **Key fail** appears.



If you transmit or receive an unencrypted call on an encrypted network, the  disappears and your radio may be programmed to issue an audible alert.

Removing encryption keys from the radio

It may be possible for you to delete encryption keys from your radio.



Warning When emergency mode is activated, or when your radio is immobilized ('inhibited'), your encryption keys may be automatically deleted from your radio.



If you attempt to transmit with encryption turned on but don't have any keys loaded, the message **Key fail** appears.

Deleting an encryption key

- 1 Press **Menu** and select **Security > Zeroize key**.
- 2 Scroll to the key you want and press **Select**.

The message **Single key zeroized** briefly appears in the display.

Deleting all encryption keys

- 1 Press **Menu** and select **Security > Zeroize all**.

The message **Zeroize all keys?** appears in the display.

- 2 Press **OK** and the message **All keys zeroized** briefly appears in the display and  no longer appears.

11 Customizing radio settings

This section describes the ways in which you can customize your radio.



These features are common to radios operating in either trunked or conventional mode.

This section covers:

- [Changing the volume of all audible indicators](#)
- [Changing the volume of keypress tones](#)
- [Changing to quiet operation](#)
- [Changing to silent operation](#)
- [Changing the external alert option](#)
- [Turning on backlighting](#)
- [Adjusting the display contrast](#)

Changing the volume of all audible indicators

You can set the volume of all the audible indicators to either high or low. Audible tones include incoming call tones, warning tones and confirmation tones.

To change the volume of your radio's audible tones:

- 1 Press **Menu** and select **Radio settings > Alert settings > Indicator level**.

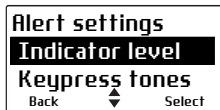

(Depending on how your radio is programmed, you may be able to press a function key to change the level of indicators.)

- 2 Scroll to **High** (or **Low**) and press **Select**.

Changing the volume of keypress tones

Whenever you press the radio keys, the keypress tones give you an audible indication as to whether or not your action is allowed. A short, medium-pitched beep indicates that an action is allowed. A long, low-pitched beep indicates that the action is not allowed.

To change the volume of your radio's keypress tones:

- 1 Press **Menu** and select **Radio settings > Alert settings > Keypress tones**.

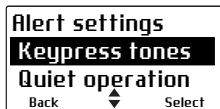

- 2 Scroll to either **Off**, **Low** or **High** and press **Select**.

Changing to quiet operation

When quiet operation is on, keypress tones and confirmation tones are turned off. Incoming call tones, signaling tones and warning tones all remain audible.

To turn quiet operation on or off:

- 1 Press **Menu** and select **Radio settings > Alert settings > Quiet operation**.

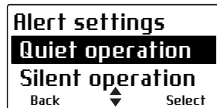

(Depending on how your radio is programmed, you may be able to press a function key to toggle quiet operation on and off.)

- 2 Scroll to **On** (or **Off**) and press **Select**.

Changing to silent operation

When silent operation is on, all the radio's audible tones are turned off, and only channel traffic can be heard.

To turn silent operation on or off:

- 1 Press **Menu** and select **Radio settings > Alert settings > Silent operation**.

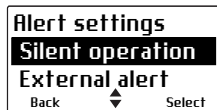

- 2 In the **Silent operation** menu, scroll to either **On** or **Off** and press **Select**.

(Depending on how your radio is programmed, you may be able to press a function key to toggle silent operation on and off.)

While silent operation is on, the  icon appears in the display.

Changing the external alert option

If you are away from your radio and unable to answer calls immediately, an external alert, such as a car horn, may activate when you receive a call. The external alert continues for a period of time and is then turned off.

To turn external alert on or off:

- 1 Press **Menu** and select **Radio settings** > **Alert settings** > **External alert**.

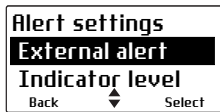

(Depending on how your radio is programmed, you may be able to press a function key to toggle external alert on and off.)

- 2 Scroll to either **On** or **Off** and press **Select**.

Turning on backlighting

Whenever a key is pressed or a call is received, the keypad and display light up automatically. Backlighting only remains on for a few seconds, unless there is further radio activity. When backlighting is turned on, it remains on until the setting is changed to **Off**, regardless of radio activity.

To turn backlighting on or off:

- 1 Press **Menu** and select **Radio settings** > **Display settings** > **Backlighting**.



(Depending on how your radio is programmed, you may be able to press a function key to toggle backlighting on and off.)

- 2 Scroll to either **On** or **Off** and press **Select**.

Turning backlighting on momentarily

You may be able to use a programmed function key to turn backlighting on momentarily.

- Press the assigned function key to turn backlighting on. Backlighting remains on for a few seconds, and then turns off.

Alternatively, the function key may be programmed so that:

- a short key press turns backlighting on momentarily, and
- a long key press turns backlighting on, and it remains on until there is a further long key press.

Adjusting the backlighting level

The radio's display can also be made either darker or lighter, to suit your working conditions.

To change the level of the backlighting:

- 1 Press **Menu** and select **Radio settings > Display settings > Backlight level**.



- 2 Scroll to either **Low**, **Medium** or **High**, and press **Select**.

Adjusting the display contrast

To change the contrast of your radio display to suit the lighting conditions that you are working in:

- 1 Press **Menu** and select **Radio settings** > **Display settings** > **Contrast adjust**.



- 2 Use the scroll keys to adjust the display contrast to the level you want.



- 3 Press **Save** to save this setting.

12 Troubleshooting

This section describes troubleshooting procedures, and basic maintenance.

If you are experiencing difficulty operating your radio, you may find the following sections helpful. Consult your radio provider for assistance, if necessary.

This section covers:

- [When the radio won't turn on](#)
- [Identifying the radio's audible tones](#)
- [Viewing radio information](#)
- [Removing the microphone](#)
- [General care](#)

When the radio won't turn on

If the red, green and orange LEDs on the control head do not light briefly up when the radio is turned on, it is probable that power is not reaching the radio. Check the following:

- Is the power connector firmly plugged into the rear of the radio?
- Are the in-line fuses in good condition?
- Is the power cable securely connected to the vehicle battery or power supply?

If all appears to be in order, but your radio still fails to operate properly, contact your radio provider for further assistance.

Identifying the radio's audible tones

The radio's audible tones can help you identify a potential problem. See ["Audible tones" on page 30](#).

Viewing radio information

Use the **Radio info** menu to view information such as the hardware and firmware version of your radio, function key settings, the radio serial number, and various radio identities.

- 1 Press **Menu** and select **Radio settings > Radio info**.
- 2 Scroll to the radio information you want to view and press **Select**.

Checking the version of your radio using the PTT key (not with hand-held control head)

- 1 Turn off the radio.
- 2 Hold down the PTT key and turn on the radio.

The firmware and hardware versions, and your radio's frequency band is briefly displayed.

Removing the microphone

i For information on installing or removing your radio from a vehicle, refer to the *Installation Guide*.

- 1 Using your thumb or forefinger, lift up one of the corners of the microphone grommet and firmly (but gently) pull that corner until the seal comes away from the cavity.

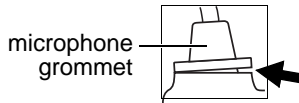

Notice Remove the grommet carefully as it serves two important functions. Firstly, it prevents damage to the microphone socket due to movement of the microphone cord, and secondly, it ensures that the control head is sealed against water, dust, and other environmental hazards.

- 2 Repeat to expose another corner.
- 3 Pull the exposed corners back and slide the grommet up the cable to reveal the microphone plug.
- 4 Remove the plug from the microphone socket.

General care

Your radio requires no regular maintenance other than ensuring that all the cables and connections are secure, and that no damage has occurred to the antenna or wiring.

Notice To prevent permanent damage to the radio cover, do not allow the radio to come into contact with detergents, alcohol, aerosol sprays or petroleum-based products.

If you need to clean the radio cover, use a cloth dampened with clean water. Do not immerse the radio in fluids.

Simplified Declaration of Conformity

EN Hereby, Tait International Limited declares that the radio equipment type TMBB1A, TMBH5A & TMBH7A is in compliance with Directive 2014/53/EU.

The full text of the EU declaration of conformity is available at the following internet address: www.taitradio.com/euodoc

BG С настоящото Tait International Limited декларира, че този тип радиосъоръжение TMBB1A, TMBH5A & TMBH7A е в съответствие с Директива 2014/53/ЕО.

Цялостният текст на ЕС декларацията за съответствие може да се намери на следния интернет адрес: www.taitradio.com/euodoc

ES Por la presente, Tait International Limited declara que el tipo de equipo radioeléctrico TMBB1A, TMBH5A & TMBH7A es conforme con la Directiva 2014/53/UE.

El texto completo de la declaración UE de conformidad está disponible en la dirección Internet siguiente: www.taitradio.com/euodoc

CS Tímto Tait International Limited prohlašuje, že typ rádiového zařízení TMBB1A, TMBH5A & TMBH7A je v souladu se směrnicí 2014/53/EU.

Uplné znění EU prohlášení o shodě je k dispozici na této internetové adrese: www.taitradio.com/euodoc

DA Hermed erklærer Tait International Limited, at radioudstyrstypen TMBB1A, TMBH5A & TMBH7A er i overensstemmelse med direktiv 2014/53/EU.

EU-overensstemmelseserklæringens fulde tekst kan findes på følgende internetadresse: www.taitradio.com/euodoc

DE Hiermit erklärt Tait International Limited, dass der Funkanlagentyp TMBB1A, TMBH5A & TMBH7A der Richtlinie 2014/53/EU entspricht.

Der vollständige Text der EU-Konformitätserklärung ist unter der folgenden Internetadresse verfügbar: www.taitradio.com/euodoc

ET Käesolevaga deklareerib Tait TMBB1A, TMBH5A & TMBH7A vastab direktiivi 2014/53/EL nõuetele.

ELI vastavusdeklaratsiooni täielik tekst on kättesaadav järgmisel internetiaadressil: www.taitradio.com/euodoc

EL Με την παρούσα ο/η Tait International Limited, δηλώνει ότι ο ραδιοεξοπλισμός TMBB1A, TMBH5A & TMBH7A πληροί την οδηγία 2014/53/ΕΕ.

Το πλήρες κείμενο της δήλωσης συμμόρφωσης ΕΕ διατίθεται στην ακόλουθη ιστοσελίδα στο διαδίκτυο: www.taitradio.com/euodoc

FR Le soussigné Tait International Limited, déclare que l'équipement radioélectrique du type TMBB1A, TMBH5A & TMBH7A est conforme à la directive 2014/53/UE.

Le texte complet de la déclaration UE de conformité est disponible à l'adresse internet suivante: www.taitradio.com/euodoc

HR Tait International Limited ovime izjavljuje da je radijska oprema tipa TMBB1A, TMBH5A & TMBH7A u skladu s Direktivom 2014/53/EU.

Cjeloviti tekst EU izjave o sukladnosti dostupan je na sljedećoj internetskoj adresi: www.taitradio.com/euodoc

IT Il fabbricante, Tait International Limited, dichiara che il tipo di apparecchiatura radio TMBB1A, TMBH5A & TMBH7A è conforme alla direttiva 2014/53/UE.

Il testo completo della dichiarazione di conformità UE è disponibile al seguente indirizzo Internet: www.taitradio.com/euodoc

LV Ar šo Tait International Limited deklarē, ka radioiekārtā TMBB1A, TMBH5A & TMBH7A atbilst Direktīvai 2014/53/ES. Pilns ES atbilstības deklarācijas teksts ir pieejams šādā interneta vietnē: www.taitradio.com/euodoc

LT Aš, Tait International Limited, patvirtinu, kad radijo įrenginių tipas TMBB1A, TMBH5A & TMBH7A atitinka Direktyvą 2014/53/ES.

Visas ES atitikties deklaracijos tekstas prieinamas šiuo interneto adresu: www.taitradio.com/euodoc

HU Tait International Limited igazolja, hogy a TMBB1A, TMBH5A & TMBH7A típusú rádióberendezés megfelel a 2014/53/EU irányelvnek.

Az EU-megfelelőségi nyilatkozat teljes szövege elérhető a következő internetes címen: www.taitradio.com/euodoc

MT B'dan, Tait International Limited, niddikjara li dan it-tip ta' taghmir tar-radju TMBB1A, TMBH5A & TMBH7A huwa konformi mad-Direttiva 2014/53/UE.

It-test kollu tad-dikjarazzjoni ta' konformita tal-UE huwa disponibbli f'dan l-indirizz tal-Internet li ġej: www.taitradio.com/euodoc

NL Hierbij verklaar ik, Tait International Limited, dat het type radioapparatuur TMBB1A, TMBH5A & TMBH7A conform is met Richtlijn 2014/53/EU.

De volledige tekst van de EU-conformiteitsverklaring kan worden geraadpleegd op het volgende internetadres: www.taitradio.com/euodoc

PL Tait International Limited niniejszym oświadczam, że typ urządzenia radiowego TMBB1A, TMBH5A & TMBH7A jest zgodny z dyrektywą 2014/53/UE.

Pełny tekst deklaracji zgodności UE jest dostępny pod następującym adresem internetowym: www.taitradio.com/euodoc

PT O(a) abaixo assinado(a) Tait International Limited declara que o presente tipo de equipamento de rádio TMBB1A, TMBH5A & TMBH7A está em conformidade com a Diretiva 2014/53/UE.

O texto integral da declaração de conformidade está disponível no seguinte endereço de Internet: www.taitradio.com/euodoc

RO Prin prezenta, Tait International Limited declară că tipul de echipamente radio TMBB1A, TMBH5A & TMBH7A este în conformitate cu Directiva 2014/53/UE.

Textul integral al declarației UE de conformitate este disponibil la următoarea adresă internet: www.taitradio.com/euodoc

SK Tait International Limited týmto vyhlasuje, že rádiové zariadenie typu TMBB1A, TMBH5A & TMBH7A je v súlade so smernicou 2014/53/UE.

Uplné EU vyhlásenie o zhode je k dispozícii na tejto internetovej adrese:

www.taitradio.com/euodoc

SV Härmed försäkrar Tait International Limited att denna typ av radioutrustning TMBB1A, TMBH5A & TMBH7A överensstämmer med direktiv 2014/53/EU.

Den fullständiga texten till EU-försäkran om överensstämmelse finns på följande webbadress: www.taitradio.com/euodoc

Tait Software License Agreement

This Software License Agreement ("Agreement") is between you ("Licensee") and Tait International Limited ("Tait").

By using any of the Software items embedded and pre-loaded in the related Tait Designated Product, included on CD, downloaded from the Tait website, or provided in any other form, you agree to be bound by the terms of this Agreement. If you do not agree to the terms of this Agreement, do not install or use any of the Software. If you install or use any of the Software, that will be deemed to be acceptance of the terms of this Agreement.

For good and valuable consideration, the parties agree as follows:

SECTION 1 DEFINITIONS

"Confidential Information" means all or any information supplied to or received by Licensee from Tait, whether before or after installation or use and whether directly or indirectly pertaining to the Software and Documentation supplied by Tait, including without limitation all information relating to the Designated Products, hardware, software; copyright, design registrations, trademarks; operations, processes, and related business affairs of Tait; and including any other goods or property supplied by Tait to Licensee pursuant to the terms of this Agreement.

"Designated Products" means products provided by Tait to Licensee with which or for which the Software and Documentation is licensed for use.

"Documentation" means product and software documentation that specifies technical and performance features and capabilities; user, operation, and training manuals for the

Software; and all physical or electronic media upon which such information is provided.

"Executable Code" means Software in a form that can be run in a computer and typically refers to machine language, which is comprised of native instructions the computer carries out in hardware. Executable code may also refer to programs written in interpreted languages that require additional software to actually execute.

"Intellectual Property Rights" and "Intellectual Property" mean the following or their substantial equivalents or counterparts, recognized by or through action before any governmental authority in any jurisdiction throughout the world and including, but not limited to all rights in patents, patent applications, inventions, copyrights, trademarks, trade secrets, trade names, and other proprietary rights in or relating to the Software and Documentation; including any adaptations, corrections, de-compilations, disassemblies, emulations, enhancements fixes, modifications, translations and updates to or derivative works from, the Software or Documentation, whether made by Tait or another party, or any improvements that result from Tait processes or, provision of information services.

"Licensee" means any individual or entity that has accepted the terms of this License.

"Open Source Software" means software with freely obtainable source code and license for modification, or permission for free distribution.

"Open Source Software License" means the terms or conditions under which the Open Source Software is licensed.

“**Person**” means any individual, partnership, corporation, association, joint stock company, trust, joint venture, limited liability company, governmental authority, sole proprietorship, or other form of legal entity recognized by a governmental authority.

“**Security Vulnerability**” means any flaw or weakness in system security procedures, design, implementation, or internal controls that if exercised (accidentally triggered or intentionally exploited) could result in a security breach such that data is compromised, manipulated, or stolen, or a system is damaged.

“**Software**” (i) means proprietary software in executable code format, and adaptations, translations, de-compilations, disassemblies, emulations, or derivative works of such software; (ii) means any modifications, new versions and new releases of the software provided by Tait; (iii) means any upgrades, enhancements or other functions or features to the Software provided by Tait; and (iv) may contain one or more items of software owned by a third-party supplier. The term “Software” includes the applicable “Software Key” and does not include any third-party software provided under separate license or not licensable under the terms of this Agreement.

“**Source Code**” means software expressed in human readable language necessary for understanding, maintaining, modifying, correcting, and enhancing any software referred to in this Agreement and includes all states of that software prior to its compilation into an executable programme.

“**Software Key**” means a code or key that is supplied by Tait to access, enable and use the Software or certain functions or features of the Software.

“**Tait**” means Tait International Limited and includes its Affiliates.

Section 2 SCOPE

This Agreement contains the terms and conditions of the license Tait is providing to Licensee, and of Licensee’s use of the Software and Documentation. Tait and Licensee enter into this Agreement in connection with Tait delivery of certain proprietary Software and/or products containing embedded or pre-loaded proprietary Software.

SECTION 3 GRANT OF LICENSE

3.1. Subject to the provisions of this Agreement and the payment of applicable license fees, Tait grants to Licensee a personal, limited, non-transferable (except as permitted in Section 7), and non-exclusive license to use the Software in executable code form, and the Documentation, solely in connection with Licensee’s use of the Designated Products for the useful life of the Designated Products. This Agreement does not grant any rights to source code.

3.2. The Licensee acknowledges that one or more Software Keys may be required from Tait for the Software or certain functions or features of the Software. The Licensee may only access, enable and use such Software or functions or features of the Software with Software Keys issued by Tait. Tait may provide the Licensee with a Software Key for the Software or certain functions or features of the Software agreed to by the parties as part of this Agreement. The Software Key may control the functions or features of the Software licensed in accordance with this Agreement. The Licensee’s license to the Software Key is limited to a license to use the Software Key only to access, enable and use the Software or certain functions or features of the Software that Tait has agreed to provide to the

Licensee and only in accordance with the Documentation.

3.3. If the Software licensed under this Agreement contains or is derived from Open Source Software, the terms and conditions governing the use of such Open Source Software are in the Open Source Software Licenses of the copyright owner and not in this Agreement. If there is a conflict between the terms and conditions of this Agreement and the terms and conditions of the any applicable Open Source Software Licenses, the terms and conditions of the Open Source Software Licenses will take precedence. For information about Open Source Components contained in Tait products and the related Open Source licenses, see:

<https://www.taitradio.com/opensource>

SECTION 4 LIMITATIONS ON USE

4.1. Licensee may use the Software only for Licensee's internal business purposes and only in accordance with the Documentation. Any other use of the Software is strictly prohibited. Without limiting the general nature of these restrictions, Licensee will not make the Software available for use by third parties on a "time sharing," "application service provider," "service bureau" basis, or for any other similar commercial rental or sharing arrangement.

4.2. Licensee will not, and will not directly or indirectly allow or enable any third party to: (i) reverse engineer, disassemble, extract components, decompile, reprogram, or otherwise reduce the Software or any portion thereof to a human perceptible form or otherwise attempt to recreate the source code; (ii) modify, adapt, create derivative works of, or merge the Software; (iii) copy, reproduce, distribute, lend, or lease the Software or Documentation to any third party;

(iv) grant any sublicense or other rights in the Software or Documentation to any third party; (v) take any action that would cause the Software or Documentation to be placed in the public domain; (vi) remove, or in any way alter or obscure any copyright notice or other notice of Tait or third-party licensor's proprietary rights; (vii) provide, copy, transmit, disclose, divulge or make the Software or Documentation available to, or permit the use of the Software by, any third party or on any machine except as expressly authorized by this Agreement; or (viii) use, or permit the use of, the Software in a manner that would result in the production of a copy of the Software by any means whatsoever other than what is permitted in this Agreement. Licensee may make one copy of the Software to be used solely for archival, back-up, or disaster recovery purposes; provided that Licensee may not operate that copy of the Software at the same time as the original Software is being operated. Licensee may make as many copies of the Documentation as it may reasonably require for the internal use of the Software.

4.3. Unless otherwise authorized by Tait in writing, Licensee will not, and will not enable or allow any third party to: (i) install a copy of the Software on more than one unit of a Designated Product; or (ii) copy or transfer Software installed on one unit of a Designated Product to any other device. Licensee may temporarily transfer Software installed on a Designated Product to another device if the Designated Product is inoperable or malfunctioning. Temporary transfer of the Software to another device must be discontinued when the original Designated Product is returned to operation and the Software must be removed from the other device.

4.4. Licensee will maintain, during the term of this Agreement and for a

period of two years thereafter, accurate records relating to this license grant to verify compliance with this Agreement. Tait, or a third party nominated by Tait, may inspect Licensee's premises, books and records, upon reasonable prior notice to Licensee, during Licensee's normal business hours and subject to Licensee's facility and security regulations. Tait is responsible for the payment of all expenses and costs of the inspection, provided that Licensee shall indemnify Tait for all costs (including audit costs and legal costs on a solicitor client basis) if Licensee has breached the terms of this Agreement. Any information obtained by Tait during the course of the inspection will be kept in strict confidence by Tait and used solely for the purpose of verifying Licensee's compliance with the terms of this Agreement.

SECTION 5 OWNERSHIP AND TITLE

Tait, its licensors, and its suppliers retain all of their Intellectual Property Rights in and to the Software and Documentation, in any form. No rights are granted to Licensee under this Agreement by implication, estoppel or otherwise, except for those rights which are expressly granted to Licensee in this Agreement. All Intellectual Property developed, originated, or prepared by Tait in connection with providing the Software, Designated Products, Documentation, or related services, remains vested exclusively in Tait, and Licensee will not have any shared development or other Intellectual Property Rights.

SECTION 6 LIMITED WARRANTY; DISCLAIMER OF WARRANTY

6.1. The commencement date and the term of the Software warranty will be a

period of one (1) year from Tait shipment of the Software. If Licensee is not in breach of any obligations under this Agreement, Tait warrants that the unmodified Software, when used properly and in accordance with the Documentation and this Agreement, will be free from a reproducible defect that eliminates the functionality or successful operation of a feature critical to the primary functionality or successful operation of the Software. Whether a defect has occurred will be determined solely by Tait. Tait does not warrant that Licensee's use of the Software or the Designated Products will be uninterrupted, error-free, completely free of Security Vulnerabilities, or that the Software or the Designated Products will meet Licensee's particular requirements. Tait makes no representations or warranties with respect to any third-party software included in the Software.

6.2 Tait sole obligation to Licensee, and Licensee's exclusive remedy under this warranty, is to use reasonable efforts to remedy any material Software defect covered by this warranty. These efforts will involve either replacing the media or attempting to correct significant, demonstrable program or documentation errors or Security Vulnerabilities. If Tait cannot correct the defect within a reasonable time, then at Tait option, Tait will replace the defective Software with functionally equivalent Software, license to Licensee substitute Software which will accomplish the same objective, or terminate the license and refund Licensee's paid license fee. If Tait investigation of the perceived defect reveals that no such defect in fact exists, Tait may recover its costs in respect of such investigation from Licensee.

6.3. Tait disclaims any and all other warranties relating to the Software or

Documentation other than the express warranties set forth in this Section 6. Warranties in Section 6 are in lieu of all other warranties whether express or implied, oral or written, and including without limitation any and all implied warranties of condition, title, non-infringement, merchantability, or fitness for a particular purpose or use by Licensee (whether Tait knows, has reason to know, has been advised of, or is otherwise aware of any such purpose or use), whether arising by law, by reason of custom or usage of trade, or by course of dealing. In addition, Tait disclaims any warranty to any person other than Licensee with respect to the Software or Documentation.

SECTION 7 TRANSFERS

7.1. Licensee will not transfer the Software or Documentation to any third party without specific prior written consent from Tait. Tait may withhold such consent or at its own discretion make the consent conditional upon the transferee paying applicable license fees and agreeing to be bound by this Agreement.

7.2. In the case of a value-added reseller or distributor of Tait Designated Products, the consent referred to in Section 7.1 may be contained in a Tait Reseller or Tait Distributor Agreement.

7.3. If the Designated Products are Tait vehicle-mounted mobile products or hand-carried portable radio products and Licensee transfers ownership of the Tait mobile or portable radio products to a third party, Licensee may assign its right to use the Software which is embedded in or furnished for use with the radio products and the related Documentation; provided that Licensee transfers all copies of the Software and Documentation to the transferee.

7.4. 7.4. For the avoidance of any doubt, Section 7.3 excludes TaitNet Infrastructure, or the products listed at any time under network products at: <http://www.taitradio.com>.

7.5. If Licensee, as a contractor or subcontractor (integrator), is purchasing Tait Designated Products and licensing Software not for its own internal use but for end use only by a Customer, the Licensee may transfer such Software, but only if a) Licensee transfers all copies of such Software and the related Documentation to the transferee and b) Licensee has first obtained from its Customer (and, if Licensee is acting as a subcontractor, from the interim transferee(s) and from the ultimate end user sub license) an enforceable sublicense agreement that prohibits any other transfer and that contains restrictions substantially identical to the terms set forth in this Software License Agreement. Except as stated in the foregoing, Licensee and any transferee(s) authorised by this Section may not otherwise transfer or make available any Tait Software to any third party nor permit any party to do so. Licensee will, on request, make available evidence reasonably satisfactory to Tait demonstrating compliance with all the foregoing.

SECTION 8 TERM AND TERMINATION

8.1. Licensee's right to use the Software and Documentation will commence when the Designated Products are supplied by Tait to Licensee and will continue for the life of the Designated Products with which or for which the Software and Documentation are supplied, unless Licensee breaches this Agreement, in which case this Agreement and Licensee's right to use the Software and Documentation may be terminated immediately upon notice by Tait.

8.2. Within thirty (30) days after termination of this Agreement, Licensee must certify in writing to Tait that all copies of the Software have been removed or deleted from the Designated Products and that all copies of the Software and Documentation have been returned to Tait or destroyed by Licensee and are no longer in use by Licensee.

8.3. Licensee acknowledges that Tait made a considerable investment of resources in the development, marketing, and distribution of the Software and Documentation and that Licensee's breach of this Agreement will result in irreparable harm to Tait for which monetary damages would be inadequate. If Licensee breaches this Agreement, Tait may terminate this Agreement and be entitled to all available remedies at law or in equity including immediate injunctive relief and repossession of all non-embedded Software and associated Documentation. Licensee shall pay all Tait costs (on an indemnity basis) for the enforcement of the terms of this Agreement.

SECTION 9 CONFIDENTIALITY

Licensee acknowledges that the Software and Documentation contain proprietary and Confidential Information valuable to Tait and are Tait trade secrets, and Licensee agrees to respect the confidentiality of the information contained in the Software and Documentation.

SECTION 10 LIMITATION OF LIABILITY

10.1. In no circumstances shall Tait be under any liability to Licensee, or any other person whatsoever, whether in Tort (including negligence), Contract (except as expressly provided in this Agreement), Equity, under any Statute, or otherwise at law for any losses or damages whether general, special, exemplary, punitive, direct,

indirect, or consequential arising out of or in connection with any use or inability of using the Software.

10.2. Licensee's sole remedy against Tait will be limited to breach of contract and Tait sole and total liability for any such claim shall be limited at the option of Tait to the repair or replacement of the Software or the refund of the purchase price of the Software.

SECTION 11 GENERAL

11.1. COPYRIGHT NOTICES. The existence of a copyright notice on the Software will not be construed as an admission or presumption of publication of the Software or public disclosure of any trade secrets associated with the Software.

11.2. COMPLIANCE WITH LAWS. Licensee acknowledges that the Software may be subject to the laws and regulations of the jurisdiction covering the supply of the Designated Products and will comply with all applicable laws and regulations, including export laws and regulations, of that country.

11.3. ASSIGNMENTS AND SUBCONTRACTING. Tait may assign its rights or subcontract its obligations under this Agreement, or encumber or sell its rights in any Software, without prior notice to, or consent of, Licensee.

11.4. GOVERNING LAW. This Agreement shall be subject to and construed in accordance with New Zealand law and disputes between the parties concerning the provisions hereof shall be determined by the New Zealand Courts of Law. Provided however Tait may at its election bring proceedings for breach of the terms hereof or for the enforcement of any judgment in relation to a breach of the terms hereof in any jurisdiction Tait considers fit for the purpose of ensuring compliance with the terms hereof or obtaining relief for breach of the terms hereof.

11.5. THIRD-PARTY

BENEFICIARIES. This Agreement is entered into solely for the benefit of Tait and Licensee. No third party has the right to make any claim or assert any right under this Agreement, and no third party is deemed a beneficiary of this Agreement. Notwithstanding the foregoing, any licensor or supplier of third-party software included in the Software will be a direct and intended third-party beneficiary of this Agreement.

11.6. SURVIVAL. Sections 4, 5, 6.3, 7, 8, 9, 10, and 11 survive the termination of this Agreement.

11.7. ORDER OF PRECEDENCE. In the event of inconsistencies between this Agreement and any other Agreement between the parties, the parties agree that, with respect to the specific subject matter of this Agreement, this Agreement prevails.

11.8 SECURITY. Tait uses reasonable means in the design and writing of its own Software and the acquisition of third-party Software in order to limit Security Vulnerabilities. While no software can be guaranteed to be free from Security Vulnerabilities, if a Security Vulnerability is discovered, Tait will take the steps specified in Section 6 of this Agreement.

11.9 EXPORT. Licensee will not transfer, directly or indirectly, any Designated Product, Documentation or Software furnished hereunder or the direct product of such Documentation or Software to any country for which New Zealand or any other applicable country requires an export license or other governmental approval without first obtaining such license or approval.

11.10 SEVERABILITY. In the event that any part or parts of this Agreement shall be held illegal or null and void by any court or administrative body of competent jurisdiction, such determination shall not affect the

remaining terms which shall remain in full force and effect as if such part or parts held to be illegal or void had not been included in this Agreement. Tait may replace the invalid or unenforceable provision with a valid and enforceable provision that achieves the original intent and economic effect of this Agreement.

11.11 CONSUMER GUARANTEES. Licensee acknowledges that the licenses supplied in terms of this agreement are supplied to Licensee in business, and that the guarantees and other provisions of prevailing consumer protection legislation shall not apply.

11.12 WHOLE AGREEMENT. Licensee acknowledges that it has read this Agreement, understands it and agrees to be bound by its terms and conditions. Licensee also agrees that, subject only to the express terms of any other agreement between Tait and Licensee to the contrary, this is the complete and exclusive statement of the Agreement between it and Tait in relation to the Software. This Agreement supersedes any proposal or prior agreement, oral or written, and any other communications between Licensee and Tait relating to the Software and the Designated Products.

